

Wooden Boat Restoration & Repair

A guide to restore the structure, improve the appearance, reduce the maintenance and prolong the life of wooden boats with WEST SYSTEM® Brand epoxy



Contents

- | | | |
|-------------------|---|---|
| Section 1 | Introduction
Assessing the feasibility of restoration or repair and the potential of WEST SYSTEM® epoxy | 1 |
| Section 2 | Evaluating and Inspecting
Analysing the structure for loss of stiffness and dry rot damage, and preparing for work | 2 |
| Section 3 | Standard Techniques
Using WEST SYSTEM products safely and effectively. | 3 |
| Section 4 | Localized Dry Rot
Repairing small areas of dry rot damage. | 4 |
| Section 5 | Structural Framework Repairs
Replacing and repairing damaged frames, beams, stems, sheer clamps and keels. | 5 |
| Section 6 | Hull and Deck Planking Repairs
Repairing various types of planking, including carvel, clinker, plywood and moulded veneer. | 6 |
| Section 7 | Installing Hardware
Installing hardware with epoxy to increase the load-carrying capacity of the hardware and eliminate deck leaks. | 7 |
| Section 8 | Protective Coatings and Maintenance
Protecting against UV, finishing and maintaining wooden boats. | 8 |
| Appendix A | Estimating guide for WEST SYSTEM products | A |
| Appendix B | Tools | |
| Appendix C | Cold Temperature Bonding and Coating Techniques | |
| Appendix D | Problem solving guide | |

Wooden Boat Restoration & Repair

A guide to restore the structure, improve the appearance, reduce the maintenance and prolong the life of wooden boats with WEST SYSTEM® Brand epoxy

Catalogue No. 002-970

© Copyright March 2007 Gougeon Brothers, Inc.

© Copyright March 2007 Wessex Resins & Adhesives Limited.

Published by: Gougeon Brothers Inc. and Wessex Resins & Adhesives Limited

All rights reserved. No part of the contents of this book may be reproduced or transmitted in any form or by any means without the written permission of the publisher.

The information presented herein is believed to be reliable as of publication date, but we cannot guarantee its accuracy in light of possible new discoveries. Because Gougeon Brothers, Inc. cannot control the use of WEST SYSTEM® Brand products in customer possession, we do not make any warranty of merchantability or any warranty of fitness for a particular use or purpose. In no event shall Gougeon Brothers, Inc. be liable for incidental or consequential damages.

WEST SYSTEM, and Gougeon Brothers are registered trademarks; and Microlight and Episize are trademarks of Gougeon Brothers, Inc., Bay City, Michigan USA.

ISBN 1-899347-15-1

(Original edition ISBN 1-878207-14-8 published by Gougeon Brothers Inc., U.S.A.)

Table of contents

Section 1	Introduction	1
1.1	Assessing the feasibility of repair and restoration	2
1.2	Why wooden boats fail	3
1.3	WEST SYSTEM epoxy for wooden boat repair	4
1.4	Key steps in repair and restoration	5
Section 2	Evaluating and Inspecting the Boat	7
2.1	Understanding the Structure	7
2.2	Inspecting and locating damaged areas	10
Section 3	Standard Techniques	12
3.1	Safety	12
3.2	Epoxy products	13
3.3	Handling epoxy	15
3.4	Basic techniques	18
Section 4	Localized Dry Rot	27
4.1	Excavate and fill	27
4.2	Drilling and filling	28
4.3	Reinforcing	29
Section 5	Structural Framework Repairs	30
5.1	Laminating beams, frames and stems	30
5.2	Removal and replacement of frames	32
5.3	Removing and replacing a damaged section	32
5.4	Installing sister frames or doublers	33
5.5	Joint repairs	34
5.6	Repairing garboards	34
5.7	Keel repair	37
Section 6	Hull and Deck Planking Repairs	38
6.1	Carvel planked hulls and laid plank decks	38
6.2	Clinker (Lapstrake) planked hulls	42
6.3	Plywood	43
6.4	Moulded or laminated veneer repairs	47
6.5	Installing a teak veneer deck	50
Section 7	Installing Hardware	52
7.1	Fastener bonding	52
7.2	Hardware bonding	52
7.3	Casting epoxy bases for hardware	53
7.4	Removable hardware	55
7.5	Removing bonded hardware	55
Section 8	Protective Coatings and Maintenance	56
8.1	Sunlight and protective coatings	56
8.2	Applying the final epoxy coatings	58
8.3	Applying clear coatings	59
8.4	Paint	59
8.5	Repairing dents and cracks	60
8.6	Ventilation for longevity	60
Appendix A	Coverage charts, buying guide and physical properties of WEST SYSTEM epoxy	61
Appendix B	Wood data	62
Appendix C	Custom and commercially available tools used in this manual	64
Appendix D	Suggested further reading	65

Section One

1. Introduction

During the last thirty years, epoxy has sparked a revolution in boat building. Wood once again is a primary building material for many of today's fastest and most durable boats, both sail and power. Many of the techniques of wood/epoxy construction that have made modern wooden boats so successful can also be applied to the repair of older wooden boats with excellent results. WOODEN BOAT RESTORATION & REPAIR explains these techniques, drawing on years of testing and experience at Gougeon Brothers, Inc. and the experiences of many individual builders. The manual does not offer cheap, easy or quick repairs, for these are rarely satisfactory. However, it does offer reliable and thorough information for restoration and repair, ranging from reinstalling a cleat to rebonding the entire boat.

The technical staff at Wessex Resins have been helping customers with boat repair and restoration problems for many years. Every enquiry received concerning a project, is greeted with the same basic questions:

- ✓ What type of construction is the boat?
- ✓ What condition is the boat in?
- ✓ How will the boat be used?
- ✓ What results are desired? A quick repair, a complete restoration or something in between?
- ✓ Is there the commitment of both time and resources to enable the desired results to be achieved?
- ✓ Is wood/epoxy construction the best solution to the problem?
- ✓ How can wood/epoxy construction be used effectively for the repair?

Depending on the answers to these questions, we will attempt to formulate a reasonable plan of action with the customer and identify how wood/epoxy construction and WEST SYSTEM products might be used. Some of the questions are relatively easy — how was the boat built? What seems to be the problem? Other questions may be more difficult to define — what is the commitment to repairing the boat? Naturally, the larger the boat, the greater the damage or more thorough the restoration and the more important this question becomes. WOODEN BOAT RESTORATION & REPAIR is designed to help answer the above questions. Carefully consider each question before a commitment is made. Only when there are reasonable answers to all the questions should the real job of repairing or restoring begin. A careful analysis of these questions and perhaps a review of the manual and what the repair will involve will help to decide whether or not to buy a particular older wooden boat in need of repair.

Using the manual

WOODEN BOAT RESTORATION & REPAIR approaches a repair project in several phases.

Section 1.0 provides guidelines for assessing the feasibility of repair and restoration. It also outlines the problems typically encountered in wooden boats and explains the major uses of epoxy in repair.

Section 2.0 explains how to evaluate the soundness of the structure and locate damaged areas.

Section 3.0 provides the fundamental techniques for using WEST SYSTEM epoxy products successfully in wooden boat repairs, including surface preparation, bonding, laminating, fairing, applying woven cloth and tape, final coating and finishing. It is important to read this section carefully before beginning any of the repairs discussed in later sections.

Sections 4.0, 5.0, 6.0 and 7.0 provide detailed procedures for the most common types of repairs.

Section 8.0 discusses protection against UV light and how to finish and maintain wooden boats.

Following the procedures described in WOODEN BOAT RESTORATION & REPAIR will allow the amateur to restore the primary functions of the structure of the boat, reduce flexing and provide moisture protection. They will assure thorough, long-lasting repairs for boats or other wooden structures.

1.1. Assessing the feasibility of repair and restoration

The repair methods in this manual offer practical solutions to structural problems in wooden boats that are within the capability of the amateur. However, before embarking on a major rebuilding operation, it is important to determine the commitment required and the approach to repair together with the money available for the project.

1.1.1. Distinguish between repair and restoration

What is required? A boat faithfully restored, repaired to full working order and natural beauty, or patched and in the water as quickly as possible?

Repair means to mend broken parts, to patch holes resulting from impact or moisture damage, to strengthen weak points or tighten loose parts. If the ultimate goal is repair, epoxy is not the only material that can be used. However, what should be considered is the effects of a repair on the overall structure. For example, bonding a plank in place with epoxy could cause high local stiffness in an otherwise flexible structure. In some cases, it may be better to repair the boat in the same fashion in which it was built rather than use different bonding and construction techniques.

Restoration means to bring a boat back to its original (or better than original) condition. To restore a boat successfully it is necessary to develop an overall approach to renovation and maintain consistency in reconstruction methods. Any restoration is a major project that will involve much time, dedication and careful planning.

It is important to decide the level of repair that suits the project in hand. Theoretically, no boat is beyond restoration; realistically, it is an essential need to thoroughly evaluate the soundness of the structure and the time and expense needed for repair. If one has limited experience with rebuilding, we advise hiring a surveyor before becoming heavily involved.

1

1.1.2. Determine the commitment needed

Several factors that need to be explored in order to determine the necessary commitment to repair or restoration include:

Time and resources

Many people have become romantically involved with restoration projects and have failed to make their dreams a reality. Others have started projects which required far greater financial and time commitments than they were able to allocate and have been forced to abandon the project. It is necessary to carefully assess the money and the time that is available and can be committed. Consider, for example, restoring specific areas of the craft each year, spreading the work and expense.

Historical value

If considering the restoration of a very old boat, investigate its background to see if it has historical or collector's value. If the boat has some historical significance, wholesale repairs with epoxy may not be appropriate.

Condition of the boat

Obviously, the worse the condition of the boat, the more repair work needed to restore the craft to its former glory. While in theory no boat is beyond restoration, if less than 60 percent of the boat is salvageable it may be better to look for another boat.

Size of the craft

Reconstruction difficulty increases with boat size. This is because larger craft experience higher loads. Boat timbers are proportional to boat size and the strength and effect of epoxy can be overwhelmed by proportionately larger wood mass effects. Dimensional changes can be the result of moisture passage or temperature cycling as well as stresses from boat use. Also larger craft may have more areas that are difficult or impossible to access.

3 Introduction

Construction method

It is essential to have an understanding of the construction method originally used to build the boat and the level of difficulty involved with the repair of different construction methods. The following provides a general guide to the logistical and practical ease of reconstructing craft built using different construction methods, with the easiest listed first:

- plywood (soft and hard chine)
- strip plank
- laminated (hot and cold moulded)
- clinker (lapstrake)
- carvel (single)
- carvel (double)

If one has little experience with boat repair, reading the rest of this manual can provide a sense of the work involved in particular projects. A thorough evaluation of the structure of the boat needs to be completed as described in Section 2.0 or conducted by a surveyor. Talk to others who have undertaken similar projects. Understanding the level of commitment to the project and developing a realistic plan for repair and restoration are necessary for the project to succeed.

1

1.2. Why wooden boats fail

The nature of wood and the techniques used in boatbuilding in the past have contributed to both the beauty and the misfortune of wooden boats. The amount of work necessary to maintain wooden boats tarnished their appeal and lack of maintenance resulted in many beautiful wooden boats being devoured by the elements. Wooden boats may vary widely in age and condition, but most suffer in some degree from two common problems.

1.2.1. Loss of stiffness

Much of the appeal of wooden boats lies in the skill of the boatbuilder in joining many individually crafted pieces of wood into a single structure and the loss of original stiffness is a major cause of a deterioration in a boat. The forces acting on a boat during normal use put each joint under a continual strain. For example, when a wave or swell passes under a boat, it lifts the hull unevenly. Waves supporting the hull under the ends force the sides of the hull apart; a wave supporting the hull in the middle forces the sides together. Waves or swells crossing at an angle can lift the bow in one direction and the stern in another, causing a twist that pulls one side of the hull and deck forward and the other side aft. Other loads come from lifting the boat for storage, adding cargo and stressing the rigging under sail. Thus, a boat is under a constant state of twisting, stretching and flexing. All the joints must resist this flexing to keep the structure rigid and watertight.

The smallest movement around a fastener can weaken the holding power of the fastener, leading to more flexibility. Over time, every exterior joint that can flex is a potential source of moisture penetration. Traditional caulking methods are intended to flex and absorb the movement between adjoining pieces, but with the continual flexing, these caulking materials will eventually break down. Without regular maintenance, the caulked joints will leak. Then, high moisture content of the wood around the joint leads to loss of wood strength (see Appendix B), loss of fastener holding power, more flexibility and even more moisture penetration.

1.2.2. Dry rot

Dry rot is another cause of wooden boat damage. It is a natural decay process caused by the growth of brown rot, a type of fungus that feeds on the cellulose in wood fibre. Along with severe loss of strength, dry rot causes the wood to discolour, crack across the grain and shrink.

Dry rot is a misleading term, since wood must be damp for the fungus to exist. In fact, the following conditions must be present for the fungus to survive:

Food—an adequate supply of wood fibre

Moisture—moisture content of the wood at or near the fibre saturation point (above 20%)

Oxygen

Warmth—24-30°C is ideal for rot growth, but it can be active in temperatures as low as 10°C.

The many joints in a wooden boat are potentially ideal environments for dry rot. Wherever wood contacts wood, air circulation and evaporation will be reduced. If a leak occurs, the moisture level of the wood at a joint can easily reach the fibre saturation level and still allow enough oxygen for rot growth. Wood preservatives attempt to control rot by poisoning the food supply. This approach has had only limited success and does nothing to address the problem of loss of wood strength due to high moisture content.

1.3. WEST SYSTEM epoxy for wooden boat repair

The properties of WEST SYSTEM epoxy that make it valuable for new boat construction also make it ideal for repairing older boats. The techniques in this manual are designed to take maximum advantage of the properties of our epoxy within the limits of an existing older structure.

WEST SYSTEM epoxy is a structural marine adhesive, formulated to bond to wood.



Epoxy is used in the construction of new wooden boats that are both lightweight and very rigid. Bonding joints with epoxy provides greater bonding area than mechanical fasteners and totally seals and protects joints from moisture. Joints bonded with WEST SYSTEM epoxy are often stronger than the wood itself. Bonding with epoxy requires little clamping pressure, with staples and screws often used to hold the pieces together until the epoxy cures. As an adhesive, WEST SYSTEM epoxy is ideal for repairing existing damage and reducing flexing in the structure.

WEST SYSTEM epoxy is unequalled as a moisture barrier.

The ability of epoxy to protect wood structures from water has made modern wooden boats almost immune to dry rot. To a degree, this protection can be applied to older wooden boats by keeping the moisture content below the point where dry rot can survive.

WEST SYSTEM epoxy has excellent gap-filling qualities.

This eliminates the need for joints which fit precisely and a lot of clamping pressure.

WEST SYSTEM epoxy is easy to use and versatile.

WEST SYSTEM products include a complete line of epoxy materials and accessories developed to meet a wide range of building and maintenance needs. Both amateurs and professionals can tailor the epoxy system to meet the specific needs of the project.

WEST SYSTEM epoxy and repair information is backed by more than twenty years of experience.

Gougeon Brothers, Inc. has been manufacturing WEST SYSTEM epoxy for over twenty years and has earned a reputation for excellence in formulating practical, long-lasting and affordable epoxies for marine construction. New sail and power boats constructed with WEST SYSTEM products have dominated many classes of competition and families are cruising throughout the world in seaworthy craft built, restored or maintained with WEST SYSTEM epoxy. Gougeon Brothers, Inc. has the construction experience, research and testing facilities, and qualified technical staff to provide expert guidance to those using WEST SYSTEM products.

Wessex Resins and Adhesives Limited, manufacture and market WEST SYSTEM Brand products throughout Europe under licence from Gougeon Brothers Inc.. The company aims to achieve the same high standards of excellence pioneered and maintained by Gougeon Brothers.

5 Introduction

Wessex Resins holds Quality Assurance Registrations to BS EN ISO 9001:2000 ensuring that all products manufactured by the company conform to rigorous quality standards. In addition, WEST SYSTEM Brand epoxy is approved by Lloyds Register for bonding, laminating and fillet bonding of wood, GRP, aluminium and mild steels.

The technical staff at Wessex Resins have many years experience in the epoxy field and are in constant communication with Gougeon Brothers to keep abreast of any new developments within the WEST SYSTEM product range.

1.4. Key steps in repair and restoration

The three key steps in formulating a plan for the use of epoxy in the repair or restoration of wooden boats are:

Bonding for stiffness

Coating for moisture protection

Ventilating for longevity

1.4.1. Bonding for stiffness

1

The issue of stiffness is fundamental in our thinking about the use of epoxy in marine structures. Bonding and encapsulating wood with epoxy can greatly increase the local or overall stiffness of a boat. As mentioned above, the loss of stiffness in the original structure is one of the problems leading to deterioration of the boat. When epoxy is used to repair or restore a boat, stiffness is being introduced into the structure. Most of the time this stiffness is beneficial. Occasionally, if the job is not well planned, the newly introduced stiffness can have a detrimental effect, usually in the form of stress concentration, on the durability of the repairs or the integrity of the original boat.

If planning an overall restoration of the boat, the comprehensive use of epoxy as the adhesive and moisture coating will provide a very stiff and durable structure. Rebonding the hull planking with epoxy after cleaning the seams is one of the best jobs that can be completed.

If not planning a total rebuild, but interested in large or small local repairs to a basically sound boat, first identify the structural unit that needs to be repaired and how it is incorporated in the overall structure. We suggest looking for the logical breakdowns in the construction — scarfing a plank, rebuilding a hatch, replacing the transom, replacing a frame, rebuilding the top of a deck house, replacing the deck. Look for structural units where the newly introduced stiffness will not work against the original structure. This approach can help set limits to the repair job.

1.4.2. Coating for moisture protection

Encapsulating with epoxy offers a valuable advantage to new wooden boats by forming a continuous moisture barrier over every part of the boat, inside and out. By coating every surface of every piece of wood in the boat with at least two coats of epoxy, the moisture content of each piece remains at a constant level far below the fibre saturation level and the structure is dimensionally stable. Encapsulating is easy to accomplish while building a new boat because every piece can be coated at the most convenient point before or after it is bonded in place. Especially important is being able to coat pieces or surfaces that can no longer be reached once the structure is assembled.

Encapsulating an older or conventionally built boat is not possible unless all of the surfaces, especially the contact surfaces of joints, can be coated. This would involve disassembling the boat, piece by piece, and bonding it back together. This would involve a great deal of time and effort. However, even if it is not possible to encapsulate the entire boat, look for structural units that might be encapsulated. It may be possible to encapsulate some areas by removing and bonding one piece at a time

“Can I coat the inside of my boat with epoxy?” is a question often asked. In most cases, it is better not to coat the interior. Coating as many surfaces of the interior as is possible leaves some uncoated areas and is not the same as encapsulating. It does not ensure a continuous unbroken moisture barrier and will not eliminate joint movement or prevent moisture from entering a joint. If there is a leak, failing to coat the inaccessible contact surfaces of joints can create ideal environments for dry rot. So keeping the interior well ventilated is often a better solution than attempting to coat areas that may trap moisture. The object is always to deny at least one of the four conditions necessary for rot to survive, and, in this case keeping the wood moisture content below the saturation point. If water cannot be kept out of the structure, the next best option is to guarantee that water is not trapped inside.

1.4.3. Ventilating for longevity

Ventilation is the key to the continued longevity of any boat. No boat is maintenance-free. Either consider preventive maintenance or accept periodic rebuilding and repair. All boats—wood, fibreglass, aluminum and steel—need good ventilation. Keeping the interior as dry as possible is the best preventive maintenance for preserving the structure and making the boat more comfortable.

Clean bilges, an open interior layout, watertight deck openings and effective ventilators all work together to provide good ventilation. If questions arise about these options, we suggest consulting the books on boatbuilding, outfitting and storing your boat listed in Appendix D.

Section Two

2. Evaluating and Inspecting the Boat

To evaluate the condition of a boat the first two questions listed in Section 1.0 need to be answered:

What type of construction is the boat?

What condition is the boat in?

Understanding how the boat was built can help assess the damage that has occurred. A knowledge of the structure will help to determine not only the less obvious damage, but, more importantly, whether the damage has compromised the integrity of the boat. To assess the condition of the craft, a thorough inspection is required. This will probably involve some dismantling.

2.1 Understanding the Structure

2

Evaluating the soundness of the boat requires an understanding of how well the individual and combined structural components are performing and whether they are still able to complete the function for which they were originally designed. Most wooden boats are characterised by a structural framework covered with a protective skin.

2.1.1 The structural framework

While they may vary in size, shape and function, most wooden boats have common structural elements (*Figure 2.1*). The elements form the overall framework and work together with the planking to carry loads. The heavier framework of conventionally planked boats is designed to provide most of the stiffness of the structure. During the building, after the boat is launched or when she is hauled for service, the various structural members carry and distribute the concentrated and heavy loads of the boat. More contemporary boats with plywood skins may have less or lighter framework. Examine each of the elements to assess whether the boat still has the strength to carry the load it was designed to carry.

The **keel** is the backbone of most boats. Traditionally the heaviest, most rigid element in the structure, it provides a foundation for the rest of the structure. Like all components, the keel should not only be strong enough to resist bending but also solid enough to hold the fasteners that transfer loads from adjoining parts.

Frames and **floor timbers** run athwartships at regular intervals along the keel. The symmetrical frames give the hull shape while the floors distribute the loads from the ballast keel or engine stringers over the planking.

Deck beams connect the tops of each pair of hull frames. Collectively they tie the two halves of the hull together, preventing the hull from spreading or collapsing whilst supporting the deck skin. The end of each beam rests on and is connected to the sheer clamp and is usually connected to a frame end as well.

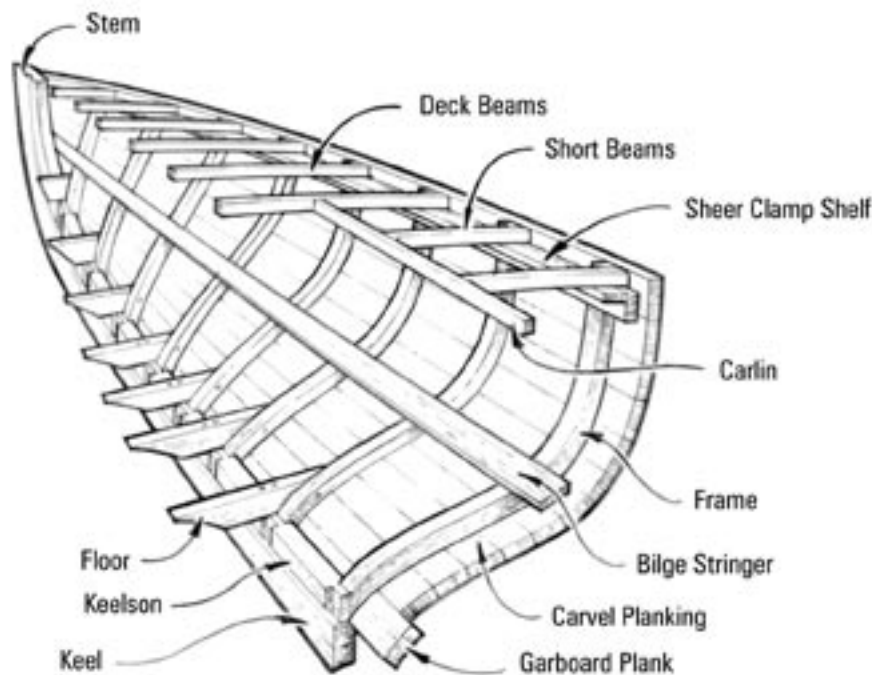

Figure 2-1 Typical structural framework.

The **sheer clamp** is connected to both the beams and the frame ends. It ties all the frame ends and beams together along the top of each side of the hull (the sheer) from stem to transom.

On larger boats a **shelf**, attached to the sheer clamp on the flat, helps to support the beams and stiffen the sheer. The clamp sits vertically against the frame ends and the shelf lies horizontally under the end of the beam. The shelf and sheer clamp are connected at approximately right angles.

Some round bottom boats may have intermediate **bilge stringers** providing additional stiffness along the turn of the bilge. These stringers, running fore-and-aft, are located halfway between the keel and the sheer clamp. On flat-bottom, multi-chine, or v-bottom boats, the intermediate fore and aft stringers are called **chines** or chine-logs. These structural members can be quite light in certain types of construction but can be very heavy, equalling the size of keel or clamp, in some traditional boats.

On power-boats and large sailboats the **engine beds** or stringers can be very large. Typically they will run some distance fore-and-aft of the engine and be tied into the floors of special bulkheads.

On some larger boats there will be **knees** or strapping installed beneath the planking and decking to resist diagonal or torsional movement. These additional reinforcing members can be wood or metal.

At cockpit or cabin openings a **carlin** ties the ends of the short or half beams to a full beam at each end of the opening. Extra knees and tie rods help to stiffen the sheer and transfer the load to the next full length beam. In a small open boat the sheer must be stiff enough to resist flexing without the aid of deck beams. In a canoe, for example, one or two thwarts replace a deck and the sheer must be stiff enough to resist flexing between the thwarts.

2.1.2 The skin

One of two basic skin types cover the hull and deck structures, providing a watertight membrane. Variations of planking provided the only alternatives for covering wooden structures for thousands of years until modern adhesives made the plywood skin more common and more durable.

Planking

Planking, whether carvel or clinker (lapstrake) or a variation of these, is more susceptible to flexing and leaks than plywood. The individual planks run generally parallel to the centreline of the boat (*Figure 2-2*). They rely on fasteners at each framing member and the caulking to resist shear movement (the slight sliding movement between planks when a hull twists). In clinker planking, where each plank overlaps the preceding one, clinch fasteners or screws along the lap serve to tighten the lap and resist shear along the lap. Joints between carvel planks were traditionally sealed with cotton and/or okum caulking driven into the seams with a caulking iron and filled over with tar or flexible sealant. Driving the caulking into the seams initially helped to stiffen the boat, but due to the fasteners being worked and the planking swelling or shrinking, caulking eventually needed to be replaced.

9 Evaluating and Inspecting the Boat

Double planking was usually two layers of carvel, or square seam planking, sealed between seams and layers with shellac, paint, bedding compounds or glue. Occasionally canvas, bedded in paint or white lead, would be used between the planking layers.

Plywood

Plywood often replaces the many individual planks, greatly reducing the number of joints that are potential sources for leaks. The framework for a plywood skin is similar to the framework for planking but, because the plywood is strong in more than one direction, the framework for plywood covered structures can be much lighter. The extra frames required in a planked structure to resist diagonal movement can be eliminated. The plywood sheets are usually glued to the framework and held in place with staples, nails or wood screws (*Figure 2-3*). Multiple layers of thinner plywood are used on surfaces with compound curves where a single thick layer cannot bend enough in both directions.

Plywood can also suffer from moisture problems. Moisture can penetrate plywood through the end grain at seams, causing delamination. On the surface, moisture causes the top veneer to check. Early plywood decks were protected with canvas laid in a fresh coat of paint or canvas cement. The fabric may have offered some protection, but because moisture can be trapped under a large area of the fabric, serious damage could be done before it is discovered. When the deck has become soft or the fabric loose, the plywood may have already lost much of its strength.

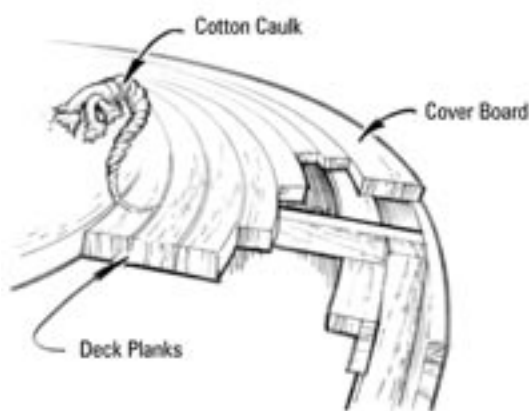

Figure 2-2 Typical laid plank deck and carvel planked hull.

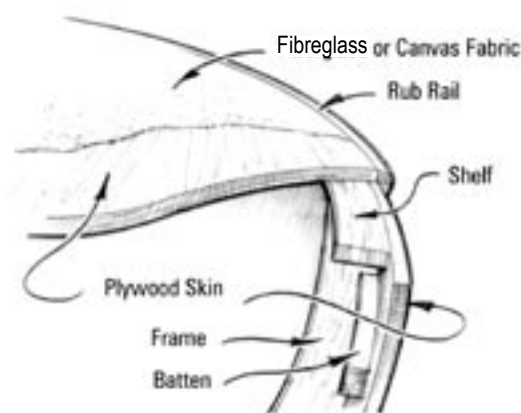

Figure 2-3 Typical plywood construction.

Hardware

Besides the problems of joints in the deck itself, deck hardware is a major source of deck leaks and moisture damage. All deck hardware is anchored to the deck with mechanical fasteners that penetrate the skin. Lightly loaded hardware may be simply screwed into the skin. Hardware items that take high loads need to be screwed or bolted through the skin into a structural member (e.g., a deck beam or extra blocking) that can transfer the load over a larger area. If all the mounting holes are not drilled precisely, the fasteners holding the hardware in place will not share the load equally. The hole with the most highly loaded fastener elongates as the hardware is stressed repeatedly. Movement reduces the load-carrying capacity of the wood fibre surrounding the fastener and creates an entry point for water. Bedding compounds, designed to minimise moisture ingress between the hardware base and the deck surface do nothing to prevent movement of the hardware. Over time, this movement will break down the bedding material and eventually allow moisture into the fastener hole. Moisture can quickly penetrate the end grain of the hole, weakening the grip of the fastener even further.

This overview of a boat's structure highlights some of the problems likely to be faced by a wooden boat owner. While these problems may be daunting, they do not have to be fatal. One of the beauties of wood is its resilience. With a little resuscitation and the proper protection, a boat can begin a long and low maintenance second life.

For a more thorough discussion of boat structure, consult the books listed in Appendix D.

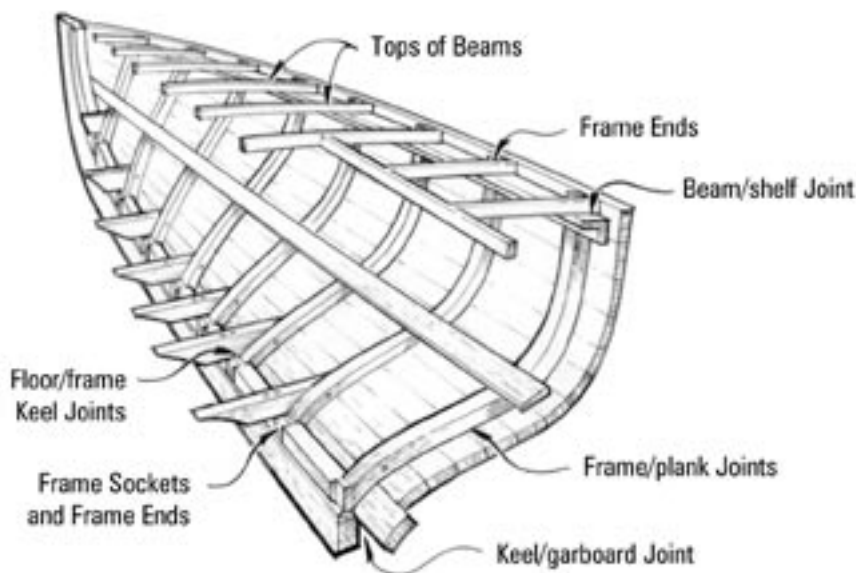

Figure 2-4 Look for dry rot at joints and areas of standing water and poor air circulation.

2.2 Inspecting and locating damaged areas

2

The first phase of repair involves inspecting and locating damaged areas. Even though damage may be obvious, finding all the hidden damage will probably require some dismantling. Because hidden damage from trapped moisture is a major problem with wooden boats, a thorough job of dismantling is important. A careful inspection will allow better decisions to be taken about the repair procedures to follow, as well as indicating the size of the job needed.

Begin the inspection as follows:

1. Support the boat in its correct shape. Stem and transom centrelines should be plumb. The sheers should be level at each station. Brace or shim the hull to prevent any movement before the repair is complete. The more parts that are bonded with epoxy, the more rigid the final structure will be. When the repairs are complete, the boat will retain the shape in which it was supported.
2. Remove equipment, hardware and accessories, canvas covering, trim and fibreglass cloth if it is loose.
3. Find the sources of leaks and the areas affected by leaks before the boat dries out. Look for damp areas, peeling paint, soft or discoloured wood. Remove the old finish as necessary to judge the condition of the wood underneath.
4. Inspect each structural member and fasteners to assess whether they can still carry their intended load. Use an ice pick or other sharp tool to probe for areas of dry rot. Look for rot in areas of poor air circulation, where parts are in contact with each other and around fasteners. If the damage is from an impact or fatigue, look for cracked frames or loose fasteners away from the damaged area (*Figure 2-4*).
5. Remove damaged material and parts that block access to suspected damage. As necessary, dismantle the skin and underlying structure in reverse order of construction until all of the damage is removed or accessible. Carefully remove and save salvageable parts for reassembly. Some parts, although damaged beyond repair, may still serve as patterns for fashioning a replacement. Removing the damage does not necessarily mean removing the entire part. Often a part can be repaired in place by scarfing in a new section or adding reinforcing (see Section 5.3).
6. Dry the boat thoroughly before beginning repairs. Remove all the remaining old finish and provide plenty of ventilation to speed the drying process. The wood moisture content should reach equilibrium at 8% - 12%. The structure will then be dimensionally stable, the epoxy will bond better and the moisture will not be sealed into the wood. Provide a dry, sheltered work area for the boat.

11 Evaluating and Inspecting the Boat

Reassess the project

Once the inspection is completed, the condition of the boat will be known and a plan can be prepared for the repair work. We urge everyone to reconsider the questions posed in Section 1:

What results are desired? A quick repair, a complete restoration or something in between?

Is there the commitment of both time and resources to enable the desired results to be achieved?

Is wood/epoxy construction the best solution to the problem?

When clear on the answers to these questions, proceed to the repair or restoration and use the later sections of this manual as appropriate. Section 3.0 provides fundamental techniques for successfully using WEST SYSTEM epoxy products in wooden boat repairs. Even if familiar with these products, it is important to have a thorough understanding of the basic techniques for surface preparation, bonding, bonding with fillets, laminating, fairing, applying woven cloth and tape, final coating and finishing which are discussed in Section 3.0. The later sections of the manual provides detailed procedures for particular types of repair and can be used in whatever order the repair requires.

Section Three

3 Standard Techniques

This chapter is designed to help everyone identify WEST SYSTEM epoxy products and to provide basic procedures for epoxy use.

3.1 Safety

By itself, WEST SYSTEM 105 Resin rarely causes skin sensitization. WEST SYSTEM Hardeners are considered skin irritants and sensitizers but this irritancy is greatly reduced when they are mixed in the correct ratio with 105 Resin. Even so, adequate handling precautions must still be taken. We recommend that the following safeguards be strictly observed.

3.1.1 Safeguards

1. Avoid all direct skin contact with resin, hardeners and mixed epoxy. Wear plastic gloves whenever handling WEST SYSTEM materials. WEST SYSTEM 831 Barrier Cream provides additional protection for sensitive skin, allergies or when there is a great deal of epoxy work to be undertaken. **DO NOT** use solvents to remove epoxy from your skin. WEST SYSTEM 820 Resin Removing Cream is recommended, followed by washing thoroughly with soap and water immediately after skin contact with resin, hardeners or solvents.
2. Protect eyes from contact with resin, hardeners, mixed epoxy and solvents by wearing protective eye glasses. If contact should occur, immediately flush eyes with liberal quantities of water under low pressure for 15 minutes, and seek medical attention immediately.
3. Avoid inhalation of vapours. Use epoxy only in areas with good ventilation. In close quarters, such as boat interiors, be especially careful to ventilate the area and provide a supply of fresh air. Wear a dust mask when sanding epoxy, taking extra care if it has cured for less than a week.
4. If a skin rash develops while working with epoxy, stop using the product until the rash disappears, usually three or four days later. After this period and once returning to work, improve safety precautions and prevent any skin contact whatsoever with resin, hardeners and mixed epoxy, as well as their fumes. If problems persist, consult a doctor.
5. Do not operate power machinery or climb ladders if working with solvents in a confined area. If feeling tired, nauseated, high or irritable while using solvents, move immediately to a well-ventilated room or go outdoors.
6. If moderate amounts of epoxy are spilled or splashed onto clothes, change immediately. Use WEST SYSTEM 820 Resin Removing Cream to remove the resin from both skin and clothes. Clean up spillage from work surfaces using a squeegee and paper towels. Scrape up as much material as possible with squeegees before using paper towels. Sand or clay type absorbent material should be used to contain or soak up large spills. Clean residue with WEST SYSTEM 850 Solvent or 855 Cleaning Solution.
7. Use extreme care with pots of mixed epoxy. Mixed epoxy will generate heat, especially when a large quantity is confined in a container offering a small surface area. **DO NOT** throw epoxy waste into the bin before it has solidified and cooled.

13 Standard Techniques

8. KEEP RESINS, HARDENERS, FILLERS AND SOLVENTS OUT OF THE REACH OF CHILDREN.

For additional safety information or data, write to:

WESSEX RESINS & ADHESIVES LIMITED,
Cupernham House, Cupernham Lane,
Romsey, Hampshire.
SO51 7LF
ENGLAND

3.2 Epoxy products

3.2.1 Resin

105 Resin — A clear, light-amber, low-viscosity, epoxy resin that can be cured in a wide temperature range to yield a high-strength, rigid solid which has excellent cohesive properties and is an outstanding bonding adhesive and moisture vapour barrier. Two types of WEST SYSTEM hardeners are formulated for use with 105 Resin. 205 and 206 Hardeners require a 5 parts by weight of resin to 1 part by weight of hardener mixing ratio. 207 and 209 Hardeners require a 3.5 parts by weight of resin to 1 part by weight of hardener mixing ratio.

3.2.2 5-to-1 ratio Hardeners

205 Hardener — Used in a majority of situations, at lower temperatures and to produce a rapid cure that develops its physical properties quickly at room temperature. A 100 gram mass of 105 Resin/205 Fast Hardener mix has a pot life of 10 to 15 minutes at 21°C. As a coating, the epoxy will cure to a solid state in five to seven hours at 21°C, and will achieve maximum strength in several days.

206 Slow Hardener — Used when a longer working and cure time is desired or to provide adequate working time at higher temperatures. A 100 gram mass has a pot life at 21°C is 25 to 30 minutes. In a thin film, the epoxy will cure to a solid state in approximately nine hours at 21°C, and will achieve maximum strength in several days.

3.2.3 3-to-1 ratio Hardeners

207 Special Coating Hardener — Mixed with 105 Resin for coating applications when a clear finish is desired, especially in humid and/or low temperature conditions. 207 contains a UV stabilization additive, but still requires long term UV protection with paint or varnish. This hardener provides excellent adhesion for bonding applications, but is not as cost effective as 205 or 206 Hardeners. A 100 gram mass provides 25-30 minutes of pot life at 21°C, and, as a coating, the epoxy will cure to a solid state in 9 to 12 hours. Further hardening will occur over the next 4-7 days.

209 Special Tropical Hardener — Used for general bonding or coating applications in extremely warm and/or humid conditions. 209 provides approximately twice the pot life and working time as 206 Slow Hardener and adequate pot life up to 43°C. May be used at normal temperatures between 18°C and 21°C when a long pot life and working time are required. A 100 gram mass provides 50-60 minutes of pot life at 21°C, and, in a thin film, will cure to a solid state in 20-24 hours at 21°C (6-8 hours at 35°C). Further hardening will occur over the next 4-9 days.

See Appendix A for a guide to the physical properties and coverage charts for the various resin/hardener combinations.

3.2.4 Fillers and additives

Throughout this manual, we will refer to **epoxy** or **resin/hardener mix**, defined as mixed resin and hardener without fillers added; reference to **thickened mix** will mean resin/hardener with either high-density or low-density fillers added. Fillers are used to thicken the basic resin/hardener mix for specific applications. Each filler possesses a unique set of physical characteristics, but the fillers can be generally categorised as either high-density or low-density.

High-density fillers

403 Microfibrés— A fine fibre blend used to thicken epoxy for general bonding and filling. Epoxy/403 mixes have superior gap-filling qualities and good strength for most bonding applications while retaining wetting and penetrating capabilities. Microfibrés help ensure 100% bonding within joints by bridging gaps. Cures to an off-white colour.

404 High-Density Filler— Specifically developed for maximum physical properties in hardware bonding applications where high-cyclic loads are anticipated. In addition, 404 can be used for filleting and gap-filling where maximum strength is necessary. Cures to an off-white colour.

405 Filleting Blend— A strong, wood-toned filler for bonding and fillets on naturally finished wood interiors. Mixes easily and requires little sanding. Cures to a brown colour and can be used to tint other WEST SYSTEM fillers.

406 Colloidal Silica— An extremely fine filler used for gap-filling, high-strength bonds and fillets. It is perhaps the most practical and versatile filler, and is the most frequently used. Can be used alone or mixed with other fillers to improve workability and smoothness. Cures to an off-white colour.

Low-density fillers

407 Low-Density Filler— A blended microballoon-based filler used to make fairing putties which are easy to sand or carve while still being reasonably strong on a strength-to-weight basis. Cures to a dark reddish-brown colour.

410 Microlight™— The ideal low-density filler for creating a light, easily-worked fairing compound. 410 handles well, mixes with greater ease than 407, is considerably easier to sand, and is more economical for large fairing jobs. Cures to a tan colour.

Figure 3-1 is a guide for selecting a filler based on the physical properties required for a particular job. Each filler is rated between 1 and 5 in each of five physical categories. Figure 3-2 shows the most appropriate fillers for specific jobs.

GENERAL CHARACTERISTICS	FILLER					
	403	404	405	406	407	410
STRENGTH (STRONGEST = 5)	3	5	4	4	1	1
WEIGHT (LIGHTEST = 5)	3	1	3	3	4	5
SANDING (EASIEST = 5)	2	1	2	2	4	5
TEXTURE (SMOTHEST = 5)	1	2	3	5	4	4
MIXING (EASIEST = 5)	5	2	4	3	2	4

Figure 3-1 Physical properties of various epoxy/filler mixtures after curing.

FILLER APPLICATION MOST SUITABLE = 5 LEAST SUITABLE = 0	FILLER					
	403	404	405	406	407	410
LAMINATING	5	1	3	4	2	1
BONDING	4	3	4	5	2	1
FAIRING	1	0	1	1	4	5
HARDWARE BONDING	2	5	4	4	0	0
FILLETING	1	2	5	4	5	4

Figure 3-2 Suitability of various fillers for specific applications.

Mixing

The viscosity of a required mix for a particular job is controlled by the amount of filler added. Figure 3-3 provides a general guide to the differences between unthickened epoxy and the three most commonly used consistencies. A buying guide for determining approximate epoxy-to-filler quantities can be found in Appendix A.

Always add fillers in a two-step process:

1. Mix the desired quantity of resin and hardener thoroughly before adding fillers. Begin with a small batch.
2. Stir in small quantities of the appropriate filler until the desired consistency is reached. Be sure all of the filler is thoroughly blended before the blend is applied.

Additives

Although additives are blended with the mixed epoxy in the same two-step process as fillers, they are not designed to thicken the epoxy. Additives are used in smaller quantities to give the epoxy additional physical properties when used as a coating.

See WEST SYSTEM USER MANUAL & PRODUCT CATALOGUE for a complete description of fillers and additives.

15 Standard Techniques





CHARACTERISTICS	Unthickened resin/hardener mix - Drips off vertical surfaces - "SYRUP" consistency.	Slightly thickened mix - Sags down vertical surfaces - "KETCHUP" consistency.	Moderately thickened - Clings to vertical surfaces, peaks fall over - "MAYONNAISE" consistency.	Maximum thickness - Clings to vertical surfaces, peaks stand up - "PEANUT BUTTER" consistency.
GENERAL APPEARANCE				
USES	Coating - "Wetting Out" before bonding - fibreglass, graphite fibres application.	Laminating - bonding flat panels, large surface areas - injecting with syringe.	General bonding - filleting - hardware bonding.	Gap filling - filleting - fairing putty - bonding uneven surfaces.

Figure 3-3 Each batch of epoxy can be tailored to the most appropriate consistency for a particular job. Measure the consistency and amount of filler added by eye.

3.3 Handling epoxy

3.3.1 Dispensing

Most problems related to the curing of epoxy can be traced to the incorrect mixing ratio of resin and hardener. To simplify metering, we recommend using calibrated WEST SYSTEM Mini Pumps to dispense the resin and hardener.

3

Mini pumps

301 Mini Pumps provide a 5-to-1 ratio by weight for use with 105 Resin and **205 or 206** Hardeners.

303 Special Ratio Mini Pumps provide a 3.5-to-1 ratio by weight for use with 105 Resin and **207 or 209** Hardeners.

Both pumps will deliver the correct working ratio with **one pump stroke of resin for every one pump stroke of hardener.**

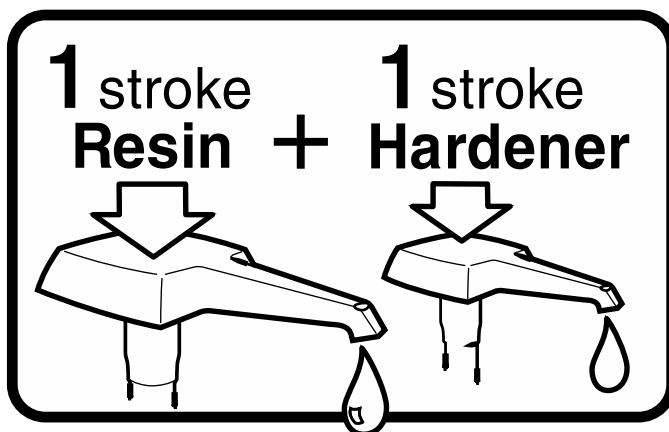

Before using the first mix on a project, verify the pumps dispense accurately at the correct ratio for the resin and hardener being used. Re-check the ratio if at anytime problems with curing are experienced.

To verify the dispensed volume from the mini-pumps, check weigh the components to confirm the correct ratio by weight as below:

105 Resin and 205 or 206 Hardener by weight, combine five parts resin with one part hardener.

105 Resin and 207 or 209 Hardener by weight, combine three and a half parts resin with one part hardener.

Dispense WEST SYSTEM resin and hardener into a clean plastic, metal or waxed paper container. Do not use glass or foam containers because of the potential danger from heat build-up produced from the exothermic reaction.

3.3.2 Mixing

Mixing epoxy involves three separate steps:

1. Dispense the correct ratio of the resin and hardener into a mixing pot. If unfamiliar with the pot life or coverage of the epoxy begin with a small batch.
2. Thoroughly stir the two ingredients together with a wooden mixing stick (2 to 3 minutes is recommended). Scrape the sides and bottom of the pot when mixing. Use a mixing stick to reach the inside corner of the pot.
3. Thoroughly stir in additives, such as pigments and fillers, if required.

If using the mix from a roller pan, mix the resin/hardener in a mixing pot before transferring the mixture to the pan. Do not use a power mixer unless the sides and corners are thoroughly scraped while mixing.

WARNING! Heat is generated by the chemical reaction that cures epoxy. If left to stand for its full pot life in a plastic mixing cup, the mixed epoxy will generate enough heat to melt the plastic. If a pot of mixed epoxy begins to exotherm (heat up), quickly move the epoxy outdoors. Avoid breathing the fumes. Do not dispose of the mixture until the reaction is complete and has cooled.

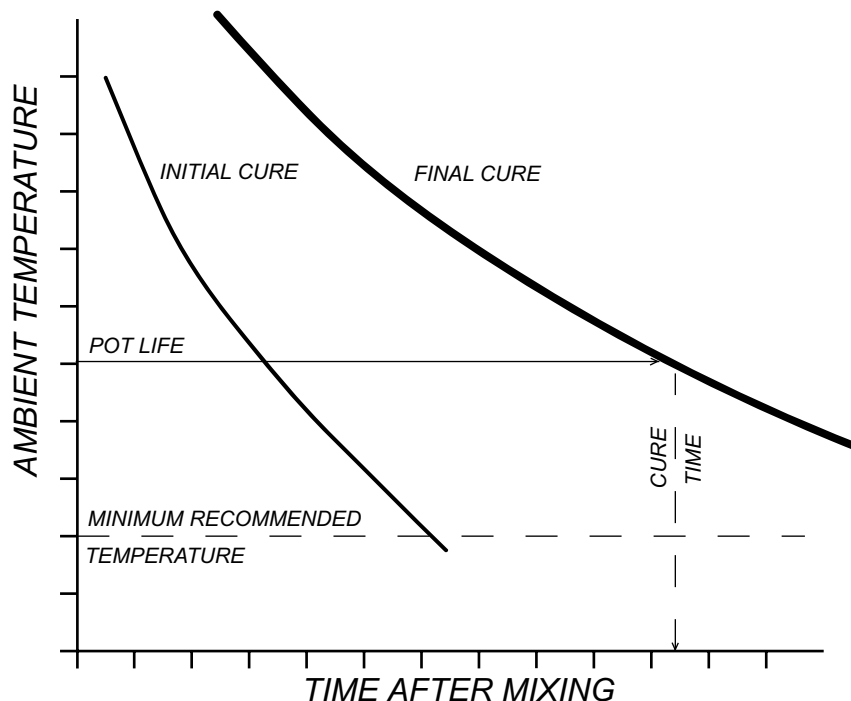

Figure 3-4 All WEST SYSTEM resin/hardener combinations go through the same stages of cure. Note that at higher temperatures each stage is shorter.

3.3.3 Cure time

Mixing epoxy resin and hardener together begins a chemical reaction that gradually changes the combined ingredients from a liquid to a solid. This transition period is generally known as the **cure time** and can be divided into three distinct phases. *Figure 3-4* illustrates the following three phases of cure:

1. Pot life and wet lay-up time

“Pot life” or working life is the phase of the cure when the resin/hardener remains workable and suitable for application after mixing. “Wet lay-up time” or assembly time, is that portion of the pot life between application of the mixed epoxy to the surface and the last opportunity to apply clamping pressure to the assembly before the epoxy has cured too much for a dependable bond. Since the mixed epoxy will continue to cure whether it is applied to the surface or left in the mixing pot, the sooner the mix is applied, the greater the useful pot life available for assembly time.

17 Standard Techniques

2. Initial cure

The pot life is over when the mix reaches an initial or partial cure phase (sometimes called the green stage). At this point the epoxy will feel tack free and the reaction appears to be complete. It is hard enough to be shaped with files or planes, but too soft to dry sand. It will still be possible to dent the epoxy with your thumb nail. It may still be bonded to or re-coated at this point, without sanding.

3. Final cure

In the final cure phase, the epoxy compound will have cured sufficiently to allow sanding and shaping, and must be sanded before re-coating. It should not be possible to dent the epoxy with your thumbnail. At this point the epoxy will have reached about 90% of its ultimate strength, so clamps can be removed. The epoxy will continue to cure over the next several days at room temperature conditions.

3.3.4 Controlling cure time

Several factors affect the length of pot life, wet lay-up time and overall cure time of an epoxy mixture:

1. Type of hardener

Each resin/hardener combination will go through the same cure phases, but at different times (Figure 3-5). Section 3.2 lists the hardeners with their pot lives and cure times. Choose the hardener that provides adequate working time for the job in hand at the temperature and conditions under which the work will be completed. Pot life can also be manipulated by mixing 205 Fast and 206 Slow Hardeners. It is critical, however, that the correct resin-to-hardener ratio is maintained for the resin/hardeners being used. **Do not mix 205 or 206 (5-to-1 ratio by volume) Hardeners with 207 or 209 (3-to-1 ratio by volume) Hardeners.**

2. Mixed quantity

Mixing resin and hardener together creates an exothermic (heat producing) reaction. The greater the quantity, the more heat generated, the shorter the pot life and cure time. Smaller batches of epoxy generate less heat than larger batches and have longer pot lives and cure times. Similarly, a thicker joint or layer of epoxy will cure more quickly than a thin layer.

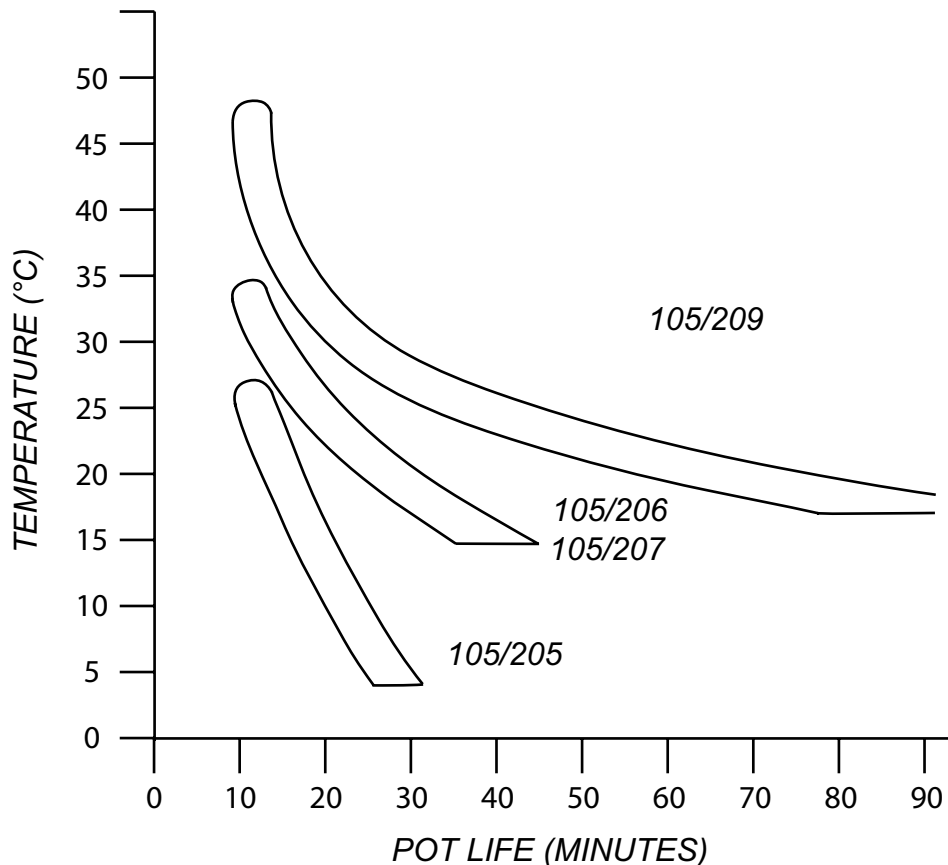

Figure 3-5 Pot life vs temperature for WEST SYSTEM hardeners. Humidity = 30%R.H. Mixed quantity = 100g

3. Temperature

An industrial hot air gun, hair dryer or heat lamp can be used to heat the applied epoxy and shorten its cure time, or a fan can be used to draw heat from the surface and extend the cure time. **DO NOT** heat the epoxy over 50°C. Be aware that heating epoxy that has been applied to a porous material, such as wood, may cause “out-gassing” (air expands and passes from the material, forming bubbles in the epoxy coating). This would only be a concern if a clear finish is desired.

4. Container shape

The heat generated by a quantity of a resin/hardener mix can be dissipated by pouring the mix into a container with greater surface area (a roller pan, for example), thereby extending the pot life.

Regardless of what steps are taken to control the cure time, thorough planning of the application and assembly will allow the maximum use of the working life of the mix.

3.3.5 Cleanup

Remove excess or spilled resin and mixed epoxy with 850 Cleaning Solvent or acetone. First scrape up as much excess or spilled material as possible with a squeegee, sharpened mixing stick or a putty knife. Wipe up the residue with a clean rag or paper towel dampened with 855 Cleaning Solution or 850 Cleaning Solvent.

If resin, hardener or uncured epoxy comes into contact with skin, wash with WEST SYSTEM 820 Resin Removing Cream followed by soap and water.

WARNING! DO NOT USE SOLVENTS DIRECTLY ONTO SKIN. READ THE DIRECTIONS AND HEALTH AND SAFETY INSTRUCTIONS ON SOLVENT CONTAINERS BEFORE USING.

3.4 Basic techniques

3

The following procedures are basic operations that will be used continuously regardless of the type of structure or material. A list and description of the tools referred to in this section can be found in Appendix C.

3.4.1 Surface preparation

Whether bonding, laminating, filleting, fairing or applying fabrics, the success of the application depends not only on the strength of the epoxy, but also on how well the epoxy adheres to the surface to which it is being applied. That is why the following three steps for surface preparation are a critical part of any epoxy operation:

1. Cleaning

Surfaces must be free of any contaminants such as grease, oil, wax or mould release. Clean contaminated surfaces with WEST SYSTEM 850 Solvent, acetone or a silicone or wax remover can be used. Wipe the surface with clean paper towels before the solvent dries. Clean surfaces before sanding to avoid sanding the contaminant into the surface. **CAUTION!** Follow all safety precautions when working with solvents.

2. Drying

All bonding surfaces must be as dry as possible for good adhesion. If necessary, accelerate drying by warming the bonding surface with hot air guns, hair dryers or heat lamps. Use fans to move the air in confined or enclosed spaces. Watch for condensation when working outdoors or whenever the temperature of the work environment changes.

3. Sanding

Sand hardwoods and non-porous surfaces thoroughly to obtain an abraded surface. 80-grit aluminum oxide paper should be used to provide a good mechanical key for the epoxy. Be sure the surface to be bonded is solid. Remove any flaking, chalking, blistering, or old coating before sanding. Remove all dust after sanding.

19 Standard Techniques

Removing amine blush

Amine blush is a by-product of the epoxy curing process that may appear as a wax-like film on epoxy surfaces during the final cure phase. The blush is water soluble and can easily be removed, but can clog sandpaper and inhibit subsequent bonding if not removed. Wash the surface thoroughly with 855 Cleaning Solution and then wash with clean water and an abrasive pad such as a 3-M Scotch-brite™ general purpose hand pad. Dry the surface with plain white paper towels to remove the dissolved blush before it dries on the surface. After washing with the abrasive pad, the surface should appear dull. Sand any remaining glossy areas with 80-grit sandpaper.

When to sand

If an impression can be made in the epoxy with your thumbnail, it is not hard enough to sand, and can still be recoated without sanding. If there is any doubt or if the surface feels waxy, allow the epoxy to cure fully, then wash and sand.

3.4.2 Bonding

This section refers to two types of bonding. Single-step bonding is occasionally used when joints have minimal loads and excess absorption into porous surfaces is not a problem. Two-step bonding is the preferred method for most situations because it promotes maximum epoxy penetration into the bonding surface and prevents resin-starved joints.

Two-step bonding

Before mixing the epoxy, ensure all parts to be bonded fit properly and that surface preparation has been completed. Gather all clamps and tools necessary for the operation, and cover any areas that need protection from spills.

1. Wet-out

Apply a straight resin/hardener mix (without fillers) to the surfaces to be joined (*Figure 3-6*). This is called wetting-out the surface. The resin/hardener mix may be applied with a disposable brush for small or tight areas, or a foam roller for larger areas. A large horizontal area can also be wet out by spreading the resin/hardener mix evenly over the surface with a plastic squeegee. Proceed immediately with step two.

2. Applying thickened epoxy

Modify the resin/hardener mix by stirring in the appropriate filler until it becomes thick enough to bridge any gaps between the mating surfaces.

Apply an even coat of the thickened blend to **one** of the surfaces to be joined (*Figure 3-7*).



Figure 3-6 Wet out the bonding surface with unthickened epoxy for maximum penetration and to prevent resin-starved joints.



Figure 3-7 Apply enough thickened epoxy to one of the bonding surfaces to squeeze out of the joint slightly when clamped.

The thickened epoxy can be applied immediately over the epoxy coated surface or at any time before the epoxy reaches its final cure. For most small bonding operations, add the filler to the resin/hardener mix remaining in the batch that was initially used for the wetting out. Mix enough resin/hardener for both steps. Add the filler quickly after the surface is wet out and allow for a shorter working life of the mix. Fully cured epoxy surfaces that have been washed and sanded do not need to be wet out.

Apply enough of the mix so that a small amount will squeeze out when the surfaces are joined together with a force equivalent to a firm hand grip.

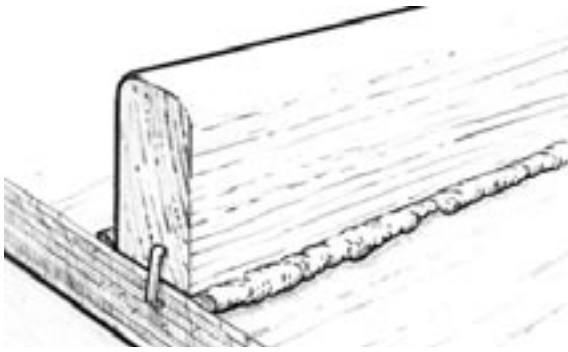

Figure 3-8 A small amount of epoxy will squeeze out of the joint with the right amount of thickened mix and clamping pressure.

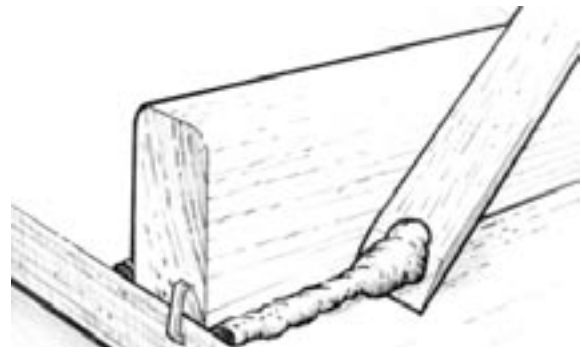

Figure 3-9 Remove excess epoxy before it begins to cure. A sharpened mixing stick makes an excellent cleanup tool.

Single-step bonding

Single-step bonding is applying the thickened epoxy directly to the component without first wetting out with resin/hardener only. We recommend that:

- (a) the epoxy is thickened no more than is necessary to bridge gaps in the joint (the thinner the mix, the more it can penetrate the surface) and,
- (b) that this method is not used for highly loaded joints or for bonding end grain or other porous surfaces.

Clamping

When the parts being bonded are properly positioned, attach clamps as necessary to hold the components in place. Use just enough clamping pressure to squeeze a small amount of the epoxy from the joint, indicating that the epoxy is making good contact with both mating surfaces (*Figure 3-8*). Avoid squeezing all the epoxy mix from the joint by using too much clamping pressure.

Any method of clamping is suitable as long as the parts to be joined are held so that movement will not occur. Methods of clamping include spring clamps, “C” clamps and adjustable bar clamps, heavy rubber bands cut from inner tubes, nylon-reinforced packaging tape, and heavy weights. When placing clamps near epoxy-covered areas, use polyethylene sheeting or Peel Ply under the clamps so they do not inadvertently bond to the surface. Staples, nails and drywall screws are often used where conventional clamps will not work and are removed after the epoxy cures. Any fasteners that need to be left in should be a non-corroding alloy such as bronze.

Shape or remove any excess adhesive that squeezes out of the joint as soon as the joint is secured with clamps. A wooden mixing stick with one end sanded to a chisel edge is an ideal tool for removing the excess (*Figure 3-9*).

3.4.3 Bonding with fillets

A fillet is a cove-shaped application of thickened epoxy that bridges an inside corner joint. It is excellent for bonding parts because the surface area of the bond is increased and serves as a structural brace. All joints that will be covered with fibreglass cloth will require a fillet to support the cloth at the inside corner of the joint.

The procedure for bonding with fillets is the same as normal bonding except that instead of removing the squeezed-out thickened epoxy after the components are clamped in position, the epoxy/filler blend is shaped into a fillet. For larger fillets, add thickened mix to the joint as soon as the bonding operation is complete, before the bonding mix is fully cured, or at any time after the final cure and sanding of exposed epoxy in the fillet area.

21 Standard Techniques

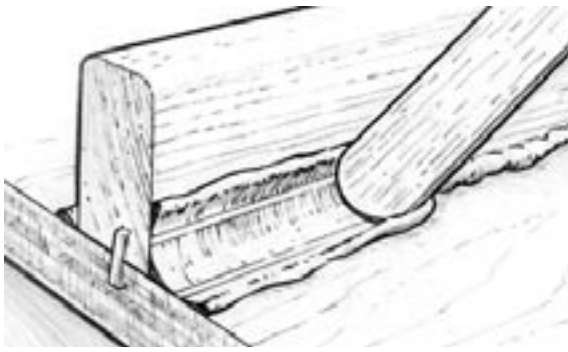

Figure 3-10 Shape and smooth the fillet with a rounded filleting tool.

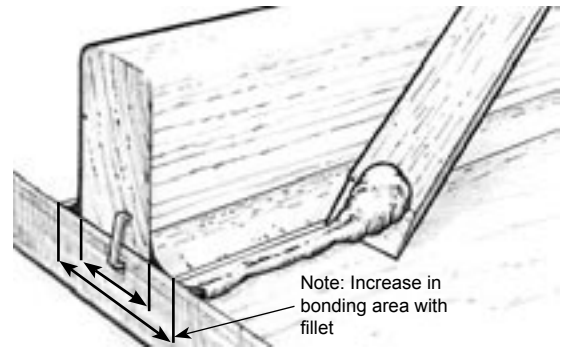

Figure 3-11 Clean up remaining excess epoxy outside of the clean margin before it cures.

1. Mix the resin/hardener/filler to a non-sagging peanut butter consistency.
2. Apply the fillet mix along the joint line with a rounded mixing stick, using enough mix to create the desired size of fillet. For larger or multiple fillets, empty caulking gun cartridges or disposable cake decorating bags can be used. Cut the plastic tip of the cartridge or bag to lay a bead of thickened epoxy large enough for the desired fillet size. Heavy duty, sealable food storage bags with one corner cut off may also be used.
3. Shape and smooth the fillet by drawing a rounded filleting tool (mixing stick) along the joint, dragging excess material ahead of the tool and leaving a smooth cove-shaped fillet bordered on each side by a clean margin. Some excess filleting material will remain outside of the margin (*Figure 3-10*). Use the excess material to re-fill any voids. Smooth the fillet until satisfied with the appearance. A mixing stick will produce a fillet of about a 9mm radius. For larger fillets, an 808 Plastic Squeegee, cut to shape or bent to the desired radius, is recommended.
4. Clean up the remaining excess material by using a sharpened mixing stick or a putty knife (*Figure 3-11*). Fibreglass cloth or tape may be applied over the fillet area before the fillet has cured (or after the fillet is cured and sanded).
5. Sand smooth with 80-grit sandpaper after the fillet has fully cured. Wipe the surface clean of any dust and apply several coats of resin/hardener over the entire fillet area before final finishing.

3

3.4.4 Laminating

The term laminating refers to the process of bonding numbers of relatively thin sheets, like plywood, veneers, fabrics or core material. The laminate may be any number of layers of the same material or combinations of different materials. Methods of epoxy application and clamping will differ depending on what is being laminated.

Because of large surface areas and limitations of wet lay-up time, a roller is the most common application method. A faster method for large surfaces is to simply pour the resin/hardener mix onto the middle of the panel and spread the mixture evenly over the surface with a plastic squeegee. Apply thickened epoxy mix with a WEST SYSTEM 809 Notched Spreader.

Staples or screws are the most common method of clamping when there is a solid substrate on which to fasten.

An even distribution of weights will work when laminating over a base that will not hold staples or screws, such as a foam or honeycomb core material.

The ideal clamping method is vacuum bagging, which, through the use of a vacuum pump and plastic sheeting, applies perfectly even pressure over all areas of the panel regardless of the size, shape or number of layers. Because of the equipment involved, it is usually used by (but not restricted to) professional builders. More information can be found in *ADVANCED VACUUM BAGGING TECHNIQUES* published by Gougeon Brothers, Inc.

3.4.5 Fairing

Fairing refers to the filling and shaping of low areas so they blend with the surrounding surfaces and appear “fair” to the eye and touch. After major structural repairs have been completed, final fairing can be easily accomplished with WEST SYSTEM epoxy and low-density fillers.

1. Prepare the surface as outlined in Section 3.4.1. Sand smooth any bumps or ridges on the surface and remove all dust from the area to be faired.

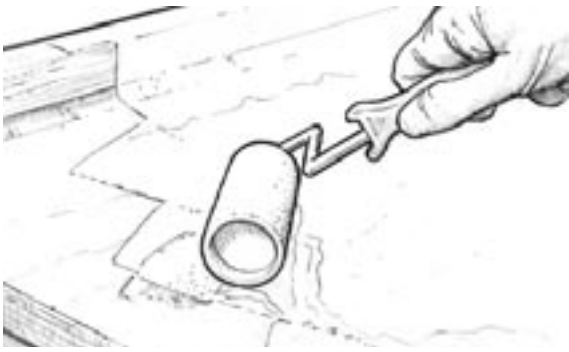

Figure 3-12 Wet out porous surfaces before applying thickened fairing compound.

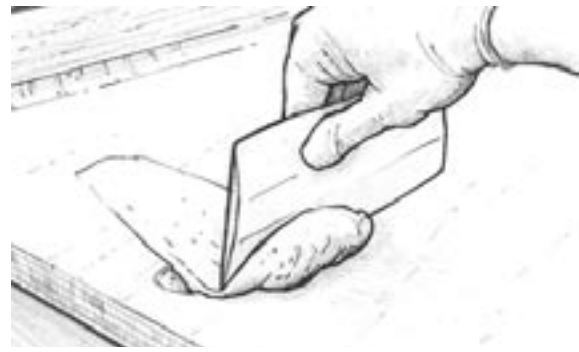

Figure 3-13 Trowel the thickened epoxy/low-density filler into voids and depressions with a plastic squeegee.

2. Wet out porous surfaces with unthickened epoxy (*Figure 3-12*). When cured, wash and sand these epoxy surfaces.
3. Mix resin/hardener and either of the low-density fillers to a peanut butter consistency.
4. Trowel on the thickened epoxy mix with a plastic squeegee, working it into all voids and depressions. Smooth the epoxy/filler blend to the desired shape, leaving the mix slightly higher than the surrounding area (**Figure 3-13**). Remove any excess thickened epoxy before it cures. If filling voids that are over 12mm deep, apply the fairing mix in several applications or use 206 Slow Hardener.
5. Allow the final thickened epoxy application to thoroughly cure.



Figure 3-14 Sand the fairing compound to the desired shape after the epoxy has reached final cure.

6. Sand the fairing material to blend with the surrounding contour (*Figure 3-14*). Begin with 50-grit sandpaper if it is necessary to remove a lot of fairing material. Use 80-grit paper on the appropriate sanding block when close to the final contour. Remove the sanding dust and fill any remaining voids following the same procedure.

CAUTION: Do not forget to wear a dust mask!

7. Once satisfied with the fairness, apply several coats of epoxy to the area with a disposable brush or roller. Allow the final coat to cure overnight before final sanding and finishing.

3.4.6 Applying woven cloth & tape

Glass cloth may be applied by two methods to provide reinforcement and/or abrasion resistance. It is usually applied after fairing and shaping are completed, and before the final coating operation. The “wet” method refers to the cloth being applied to an epoxy-coated surface before the coat reaches its initial cure.

The “dry” method refers to applying the cloth over a dry surface, either before the surface has been wet out or after the wet-out coat has reached its initial cure (or final cure and sanding). **The wet method is preferred whenever possible.**

Wet method

By working with small quantities of mixed epoxy it is possible to work at a comfortable pace with no limit to the area which is to be reinforced.

1. Prepare the surface as discussed in Section 3.4.1.
2. Pre-fit and trim the cloth to size. Roll the cloth neatly so that it may be conveniently rolled back into position later.
3. Roll a heavy coat of epoxy onto the surface.

23 Standard Techniques

- Unroll the glass cloth over the wet epoxy and position. Surface tension will hold most cloths in position. (If applying the cloth vertically or overhead, it is possible to wait until the epoxy becomes a little tacky.) Work out wrinkles by lifting the edge of the cloth and smoothing from the centre with a gloved hand or a squeegee. If cutting a pleat or notch in the cloth to lay it flat on a compound curve or corner, make the cut with a pair of sharp scissors and temporarily overlap the edges.



Figure 3-15 Spread the epoxy from the centre of the fabric toward the edges with a plastic squeegee or a roller.



Figure 3-16 Trim excess cloth when the epoxy reaches initial cure. The wet-out cloth will be dry but still flexible, and will trim easily with a sharp utility knife.

- Any areas which appear to be dry, (white in appearance), re-apply epoxy with a foam roller.
- Squeegee away excess epoxy before the first batch begins to gel. Drag the squeegee over the fabric, using overlapping strokes of uniform pressure. The object is to remove excess epoxy that would allow the cloth to float off the surface, and avoid creating dry spots by squeegeeing too hard. Excess epoxy appears as a shiny area, while a properly wet-out surface appears evenly transparent, with a smooth, cloth texture. Later coats of epoxy will fill the weave of the cloth.
- Further layers of glass cloth may be applied immediately repeating the steps above.
- Trim the excess and overlapped cloth after the epoxy has reached its initial cure. The cloth will cut easily with a sharp utility knife (*Figure 3-16*). Trim overlapped cloth as follows:
 - Place a metal straightedge on top of and midway between the two overlapped edges.
 - Cut through both layers of cloth with a sharp utility knife.
 - Remove the top-most trimming and then lift the opposite cut edge to remove the overlapped trimming (*Figure 3-17*).
 - Re-wet the under side of the raised edge with epoxy and smooth into place.

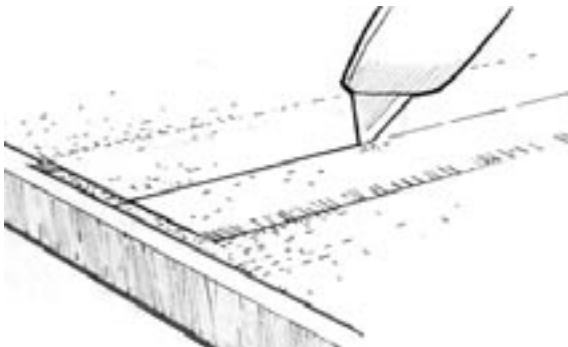

Figure 3-17a Trim overlapping cloth, using a metal straightedge and a sharp utility knife for a flush butt joint.

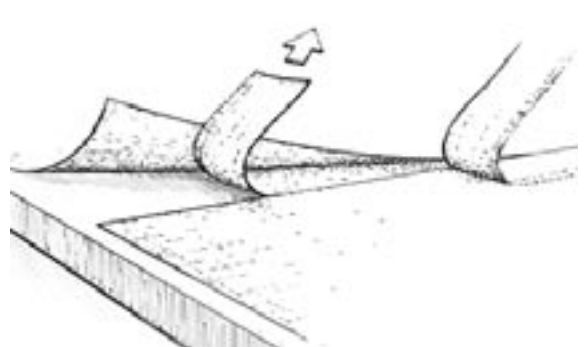

Figure 3-17b Remove the trimmings.

The result should be a near perfect butt joint, eliminating double cloth thickness. A lapped joint is stronger than a butt joint, so if appearance is not important, it may well be advisable to leave the overlap and fair in the unevenness after coating.

Any remaining irregularities or transitions between cloth and substrate can be faired by using an epoxy/filler fairing compound if the surface is to be painted. Any additional fairing completed after the final glass cloth layer should receive several additional coats over the faired area.

- Coat the surface to fill the weave before the wet-out reaches its final cure stage (*Figure 3-18*). Follow the procedures for final coating under Section 3.4.7. It will take two or three coats to completely fill the weave of the cloth and to allow for a final sanding that will not affect the cloth.

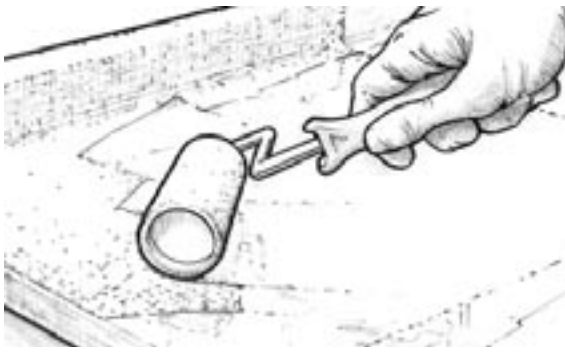

Figure 3-18 Apply the first coat of unthickened epoxy to fill the weave of the cloth before the wet-out coat reaches its final cure stage.

Dry method

1. Prepare the surface as discussed in Section 3.4.1.
2. Position the cloth over the surface and cut it several centimetres larger on all sides. If the surface area to be covered is larger than the cloth size, allow multiple pieces to overlap by approximately five centimetres. On sloped or vertical surfaces, it may be necessary to hold the cloth in place with several pieces of masking tape or with staples.
3. Mix a small quantity of epoxy (three or four pumps each of resin and hardener).
4. Pour a small pool of resin/hardener mix near the centre of the cloth.
5. Spread the epoxy over the cloth surface with an 808 Plastic Squeegee, working the epoxy gently from the pool into the dry areas (*Figure 3-15*). As the fabric is wet out it will become transparent, indicating the cloth has absorbed enough epoxy. If applying the cloth over a porous surface, be sure to leave enough epoxy to be absorbed by both the cloth and the surface below it. Dry areas will show up whiter and less transparent than a properly wet-out area. Try to limit the amount of squeegeeing as excessive “work” completed on the wet surface produces minute air bubbles which are placed in suspension in the epoxy. This is especially important if a clear finish is required. It is possible to use a roller or brush to apply the epoxy to a horizontal surface and they are essential for applying cloth to vertical surfaces.
6. Continue pouring and spreading (or rolling) small batches of epoxy away from the centre of the cloth toward the outside edges, smoothing wrinkles and positioning the cloth. Check for dry areas (especially over porous surfaces) and re-wet as necessary before proceeding to the next step. If cutting a pleat or notch in the cloth to lay it flat on a compound curve or corner, make the cut with a pair of sharp scissors and temporarily overlap the edges.
7. Follow steps 6, 7, 8 and 9 under the wet method to finish the procedure.

3

3.4.7 Final epoxy coating

The object of final coating is to build up an epoxy coating that provides an effective moisture barrier and a smooth base for final finishing.

Apply a minimum of two coats of WEST SYSTEM epoxy for an effective moisture barrier. Apply three coats if sanding is to be carried out. Moisture protection will increase with additional coats, up to six coats or about a thickness of 500 microns. Additives or pigments should not be added to the first coat. Mixing thinners with WEST SYSTEM epoxy is not recommended.

While coating, remember that the thinner the film thickness, the easier it is to control the evenness of the film thereby avoiding runs or sags in each coat. Disposable, thin urethane foam rollers, such as WEST SYSTEM 790 Roller Covers, allow greater control over film thickness, are less likely to cause the epoxy to exotherm and leave less stipple than thicker roller covers. Use WEST SYSTEM 800 Roller Covers to reach difficult areas or for long narrow surfaces like stringers.

Complete all fairing and cloth application before beginning the final coating. Allow the temperature of porous surfaces to stabilize before coating. Otherwise, as the material warms up, air under the surface may expand and escape (out-gassing) through the coating and leave bubbles on the surface of the cured coating.

1. Prepare the surface as necessary (Section 3.4.2).

25 Standard Techniques

2. Mix only enough resin/hardener as can be applied during the pot life of the mix. Pour the mixture into a roller pan as soon as it has been thoroughly mixed.
3. Load the roller with a moderate amount of the epoxy. Roll the excess out on the raised section of the roller pan to get a uniform coating on the roller.
4. Roll lightly and randomly over an area approximately 60 cm x 60 cm to transfer the epoxy evenly over the area (*Figure 3-19*).

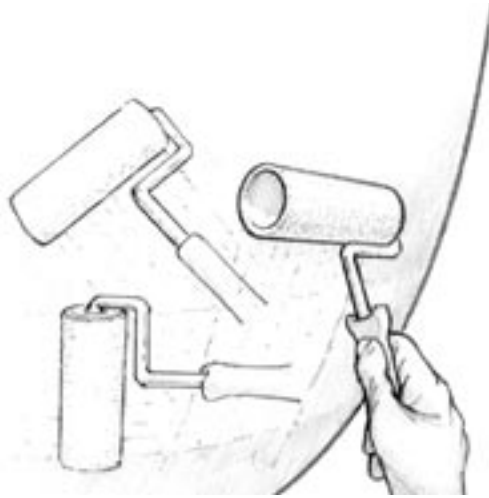

Figure 3-19 Apply the epoxy in thin even coats with a thin foam roller.

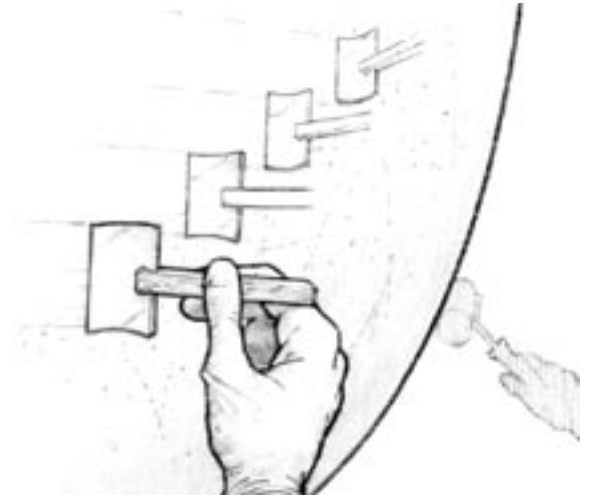

Figure 3-20 Tip off the fresh coat of epoxy with a foam roller brush to remove bubbles and roller marks.

5. As the roller dries out, increase pressure enough to spread the epoxy into a thin even film. Increase the coverage area if necessary to spread the film more thinly and evenly.
6. Finish the area with long, light, even strokes to reduce roller marks. Overlap the previously coated area to blend both areas together.
7. Coat as many of these small working areas as can be completed with each batch. If a batch begins to thicken before it can be applied, discard and mix a fresh, smaller batch.
8. Drag a foam brush lightly over the fresh epoxy in long, even, overlapping strokes after each full batch is applied. Use enough pressure to smooth the stipple, but not enough to remove any of the coating (*Figure 3-20*). See Appendix C for details on roller covers and making foam brushes.

Re-coating

Apply second and subsequent coats of epoxy following the same procedures. Make sure the previous coat has cured firmly enough to support the weight of the next coat. To avoid sanding between coats, apply all the coats in the same day. See Removing Amine Blush and When to Sand in Section 3.4.1. After the final coat has cured overnight, wash and sand to prepare the surface for the final finish.

3.4.8 Finishing

Proper finishing techniques will not only add beauty to the finished surface, but will also protect the work from ultraviolet light which may break down the epoxy over a long period of time. The most common methods of finishing are painting or varnishing. These coating systems protect the epoxy from ultraviolet light and require proper preparation of the surface before application.

Final surface preparation

Preparation for the final finish is just as important as it is for re-coating with epoxy. The surface must first be clean, dry and sanded (Section 3.4.2).

1. Allow the final epoxy coat to cure thoroughly.
2. Wash the surface with a Scotch-brite pad and water.
3. Sand to a smooth finish. The amount of sanding required will depend on how smoothly the final epoxy coatings were applied and which finishing system has been chosen.

If there are runs or sags present, begin sanding with 80-grit paper to remove the highest areas. Sand until the surface feels and looks fair, then switch to 120-grit wet or dry paper. Wet sanding is preferred by many people because it reduces sanding dust. After the scratches from the 80-grit paper are removed, switch to 220-grit paper and on to the finest grit that meets the required needs. If a primer

is to be used, 80-grit is usually sufficient. When satisfied with the texture and fairness of the surface, rinse the surface with fresh water and dry with clean paper towels.

Proceed with the final coating operation. Follow all of the instructions from the coating systems manufacturer. We suggest making a test panel to judge the level of surface preparation needed and the compatibility of the finish system.

When applying anti-fouling it is particularly important to seek the advice of the coating manufacturer as to the necessity of using a primer.

Section 4

4 Localized Dry Rot

Repairing small areas of dry rot is possibly the most common repair to wooden boats. Most structures have many small, isolated areas with poor ventilation that can trap moisture and harbour dry rot. These pockets of dry rot can often be repaired in place by excavating the damage and filling the cavity.

4.1 Excavate and fill

Remove all wood noticeably damaged by rot, making sure to extend well away from all sides of the apparent damage. Use a chisel to excavate all the weak, crumbly wood, leaving a clean cavity with solid wood exposed on all sides (*Figure 4-1*). The size of the exposed cavity will determine which of two filling methods is the most appropriate. Fill small cavities with solid thickened epoxy and fill larger cavities by bonding a “dutchman” in place (wood shaped to fill the cavity).

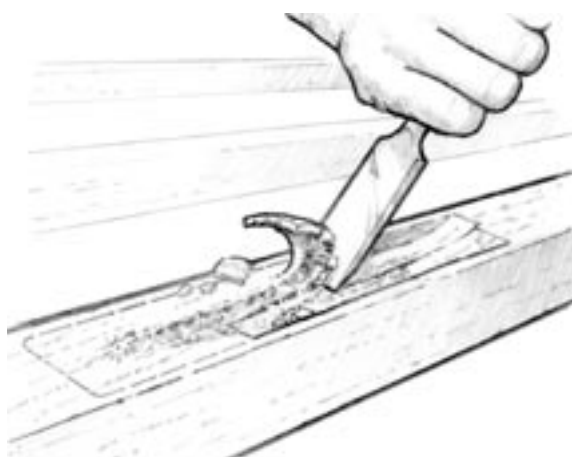

Figure 4-1 Use a chisel to excavate a cavity that extends beyond all of the damaged wood.

The decision to fill the cavity with epoxy or with wood is based on convenience, practicality and economics. Since carving intricate pieces of wood to fit hard-to-reach areas can necessitate a great deal of time and effort, filling with epoxy will save time. However, this method will add more weight and will cost more than filling with wood. In addition, due to the exothermic reaction, there is a limit to the amount of epoxy that can be used to fill cavities - approximately a 12mm layer or a volume the size of a golf ball. A larger volume would heat up causing foaming and significant weakening of the epoxy. Although the slow hardener can be used and/or the epoxy can be applied in multiple layers to avoid exotherm, there are practical limits to the size of cavity that can be filled with epoxy.

4.1.1 Filling with epoxy

Small cavities are most conveniently filled with thickened epoxy as follows:

1. Prepare the surface (Section 3.4.1). Be sure the area is thoroughly dry.
2. Wet out the repair area with the resin/hardener mix.
3. Fill the cavity with epoxy thickened with a high-density (406, 404 or 403) filler to a peanut butter consistency. Trowel the composition into the void with a squeegee or mixing stick (*Figure 4-2*). Smooth the mix flush with the surface and remove any excess before the blend begins to cure.
4. Allow the mix to cure thoroughly before sanding.



Figure 4-2 Trowel thickened epoxy into smaller voids.

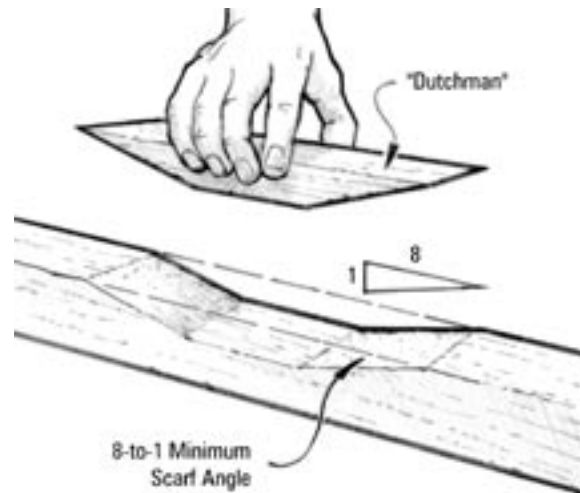

Figure 4-3 Bond a dutchman into larger cavities. Bevel the sides of the cavity and the dutchman to match.

4.1.2 Filling with wood

Larger cavities should be filled with wood wherever possible. This method restores the original strength of the wood. The procedure involves carving a dutchman to the shape of the void and bonding it in place with epoxy as follows:

1. Prepare the dutchman using the same kind of wood if possible. Carve the cavity to a geometric shape if necessary to make shaping the plug easier. Bevel the sides of the cavity. The longer the bevel on the sides running across the grain, the stronger the repair (Figure 4-3). An 8-to-1 bevel (8cm long for every 1cm deep) or greater will be close to the original strength of the wood. Check the dutchman for fit. A perfect fit is not essential as thickened epoxy will fill fairly large gaps. Prepare the surfaces for bonding (Section 3.4.1).
2. Wet out the bonding surfaces of the cavity and the plug with resin/hardener mix.
3. Apply thickened epoxy/high-density filler (406, 404 or 403) (mayonnaise consistency) to the cavity surfaces. Using the mixing stick, apply enough of the thickened compound to fill any gaps.
4. Insert the plug into position. Thickened epoxy should squeeze out of the joint.
5. Clamp the plug into position. Weights or staples may be used to hold the plug until the epoxy cures. Remove excess epoxy before it begins to cure.
6. Allow to cure thoroughly before removing clamps or sanding.

4

4.2 Drilling and filling

A common, but much less effective, method of dealing with rotted areas is to drill a pattern of holes in the affected area and inject epoxy into the holes to penetrate and stabilize the area. This is a last resort method, especially if wood strength is critical. The biggest problem with this method is that the extent of epoxy penetration into the damaged wood is not known. Testing of the physical properties of repaired samples shows drilling and filling to be inferior to excavating and filling. In addition, drilling and filling is impossible on overhead surfaces and difficult on vertical surfaces. However, it may be useful in some situations, where maximum strength is not required or the rotted area is too difficult to reach for excavating and filling. If choosing this method, we recommend the following procedure:

1. Drill a pattern of 5mm diameter holes over the rotted area. Space the holes 25 mm or less from centre to centre in all directions. Drill each hole deep enough to pass through the rot, just into solid wood. On vertical surfaces, drill the holes downward at approximately 45°.
2. Dry the area thoroughly. If necessary, use heat guns or fans to accelerate drying.
3. Inject or pour resin/hardener mixture into the holes. Warmed resin/hardener will be lower in viscosity, flow more readily and should penetrate more deeply into the exposed end grain. 206 Slow Hardener will penetrate more deeply than 205 hardener before it begins to gel (Figure 4-4).
4. Continue to inject or pour epoxy into the holes until the wood is saturated and can no longer absorb more.

29 Localized Dry Rot

5. Fill remaining voids with thickened epoxy after the epoxy reaches its initial cure, if desired. Use an epoxy/low-density filler mix for cosmetic fairing of the surface (Section 3.4.5)(Figure 4-5).

4.2.1 Thinning epoxy

There are epoxy-based products specifically designed to penetrate and reinforce rotted wood. These products, basically an epoxy thinned with solvents, will provide increased penetration of the wood, but the solvents compromise the strength and moisture barrier properties of the resin system. We are often asked if WEST SYSTEM epoxy can be thinned with solvents for greater penetration. The answer is yes, but not without some compromise in the strength and moisture resistance of the cured system. Acetone, toluene or MEK have been used to thin WEST SYSTEM epoxy and duplicate these penetrating epoxies with about the same effectiveness. If choosing to reduce the viscosity of the epoxy, remember that the strength and moisture protection of the final cured material are reduced in proportion to the amount of solvent added.



Figure 4-4 Inject resin/hardener mixture into holes until the damaged wood absorbs all it can.



Figure 4-5 Fill the remaining voids with fairing compound.

4

We recommend a better solution to provide good penetration without losing strength or moisture resistance by moderate heating of the repair area and the epoxy with a heat gun or heat lamp. The epoxy will have a lower viscosity and penetrate more deeply when it is warmed and contacts the warmed wood cavities and pores. Although the working life of the epoxy will be considerably shortened, slower hardeners (206, 207, 209) will have a longer working life and should penetrate more than 205 Hardener before they begin to gel. When the epoxy cures it will retain all its strength and effectiveness as a moisture barrier, which we feel more than offsets any advantages gained by adding solvents to the epoxy.

4.3 Reinforcing

Additional tensile strength can be obtained when working on a dry rot repair area by using synthetic fibre such as glass cloth, carbon fibre or Kevlar® in appropriate amounts with epoxy. Refer to Section 3.4.6 for application information. Apply the reinforcing after the dry rot has been excavated and filled, or drilled and filled.

Stainless steel threaded rod has also been used to reinforce and join pieces with excellent results. The rod can be bonded into drilled or grooved pieces as a structural pin to tie individual or separate pieces together. See Section 7.1 for information on bonding threaded rod.

Section 5

5 Structural Framework Repairs

Always replace or reinforce in place framework that is too weak to carry its designed load. Structural framework includes the keel, stems, hull frames, stringers, deck beams, sheer clamps, shelves, knees, carlins or thwarts. They vary widely in size, shape and position, but have many problems and repair techniques in common.

Frames can be damaged from dry rot or from impact. Under impact, frames often break in multiples. If a cracked frame is found, take time to look for others, especially adjacent to the broken one. Hull frames often break at stringer edges, the turn of the bilge and at the reverse turn (especially in the stern). Examine the outside of the hull for a knuckle or unfair spot in the planking in the area where the frames are damaged. If planks are found that are out of position, temporarily force the affected planks (and frames) back using whatever means are available. Use bracing and shims on the outside of the hull and/or rope and tackle on the inside. The frame repair can begin once the shape of the hull is restored.

Frame repairs rely on replacing damaged frames or sections of frames with material that is of equal or greater strength (see Appendix B). Laminating is an efficient method of building frames and a basic technique for the frame repairs outlined in this Section.

5.1 Laminating beams, frames and stems

Frames can be cut from solid stock or steam bent if planning to restore the structure exactly. (If steam bent frames are used, be sure to allow plenty of time for the frame to dry out before bonding.) However, laminated frames have many advantages over steam bent frames, both structurally and in ease of fabrication. Whole and partial frames are made of multiple thin layers of wood to duplicate the shape and dimension of the damaged frame (Sections 5.2, 5.3 and 5.4). There are no limitations to the size of frame that can be laminated. Laminating may be the only practical or economical way to duplicate large structural members as large timber becomes more scarce. The new frame can be laminated in a simple jig made from a pattern or, in some cases, directly in place in the hull.

5

Keep in mind the following information when selecting wood for laminating frames:

1. Choose wood strips that are the same or similar species as the original frame.
2. Use wood strips thin enough to bend easily into the shape of the original frame. Be sure all the strips collectively can bend to shape. When fewer, thicker strips are used for a given thickness of frame, more stress is induced resulting in less strength and more springback in the curved frame. Using more, thinner strips will result in a curved frame with greater strength and less springback, but requires more labour and epoxy to build.
3. Use full-length strips. Make the strips longer than the finished frame to allow for trimming.
4. The new frame width should be the same as the original frame. Strips can be wider to allow for trimming and finishing after the frame is laid up.
5. Select wood strips that are seasoned. Ideal moisture content is 6% to 14%.

5.1.1 Laminating in a jig

A laminating jig will allow a new frame to be laminated in the controlled environment of a workshop. Use cardboard or other convenient material to pattern the top or bottom line of the damaged frame. Transfer the pattern line to a laminating jig of one the types illustrated (*Figure 5-1*).

Laminate frames in a jig as follows:

1. Prepare the jig and the strips as suggested. Go through a dry run to be sure the strips bend enough and that the jig and clamps can accommodate the bending of all the strips. Cover the jig with plastic to prevent the frame from bonding to the jig.

31 Structural Framework Repairs

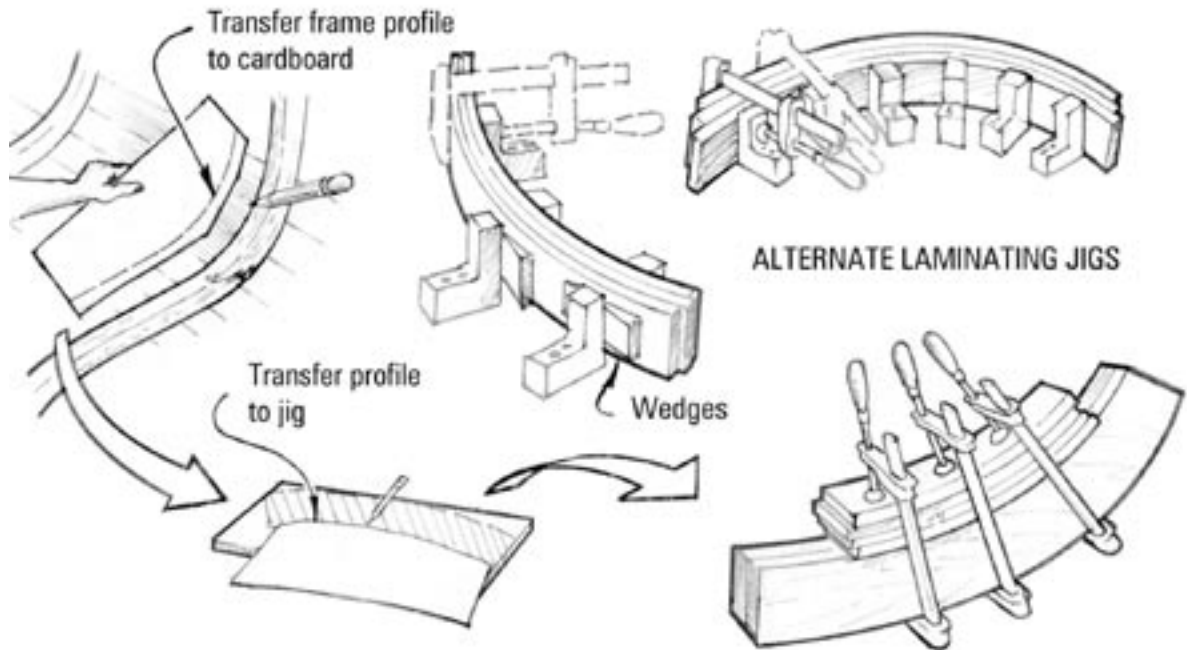

Figure 5-1 Transfer the desired frame shape to the jig.

2. Wet out the strips on both sides with epoxy, except for the outer faces of the top and bottom strip.
3. Apply thickened epoxy to one side of each strip and stack it in place on the jig against the previously coated strip. Thicken the epoxy mix with 406 filler to a ketchup consistency. Be sure one side coated with thickened epoxy faces each joint.
4. Clamp the strips to the jig until the epoxy cures (Figure 5-2). Use clamps, wedges, staples or small nails to apply enough pressure to squeeze a small amount of epoxy from each joint.
5. Remove the frame from the jig after the epoxy has thoroughly cured. Be sure to allow extra cure time if the temperature is cool, especially if expecting a lot of springback. Trim the frame to its final shape and finish as desired.

5

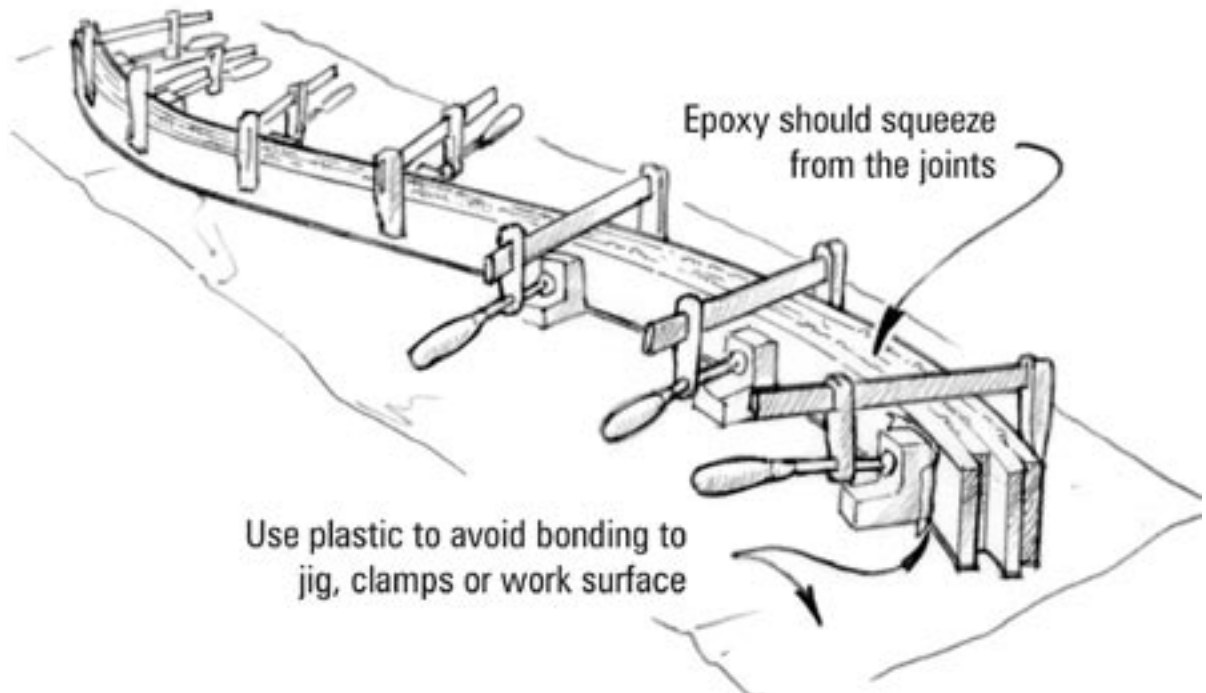

Figure 5-2 Clamp the appropriate number of coated strips into the jig. Trim the frame to size after the epoxy is fully cured.

5.1.2 Laminating frames in place

The new frame or frame section can, in some cases, be laminated directly in place in the hull. The existing structure can be used as the laminating jig in one of the following ways:

- A) Bond all the strips permanently to the structure in one continuous operation, either one at a time or all at the same time, depending on the best available clamping method. Use non-corroding screws or staples to bond strips in place one at a time, if temporary clamping is not feasible. Try a dry run to see which method will work best. Trim all the strips to size before bonding.
- B) Bond all the strips together in place with plastic over the hull contact area to prevent immediate bonding to the hull. Remove the laid up frame and trim to size. Bond the new frame back into place permanently, as previously described.

5.2 Removal and replacement of frames

Often a framing member is too damaged to be repaired and replacement is the best option. Replace a damaged frame as follows:

1. Support the hull and remaining structure before removing the frame(s). If necessary, leave some damaged frames to maintain the shape, replacing them after new frames are installed. Remove all fasteners holding the frame. If necessary, cut the damaged frames into sections to remove them.
2. Laminate the replacement frame using the instructions in Section 5.1.1. If preferred, cut or steam bend a frame to match the original. Trim the frame to fit.
3. Prepare the frame and contact area for bonding. Avoid bonding to anything that is intended to be removed later.
4. Install the frame. Wet out all contact areas with epoxy. Apply a thickened epoxy/406 mix to one side of each contact area.
5. Clamp the frame in position until the epoxy cures. If the fasteners of the old frame are to be reused, bond the fasteners with epoxy (*Figure 5-3*).

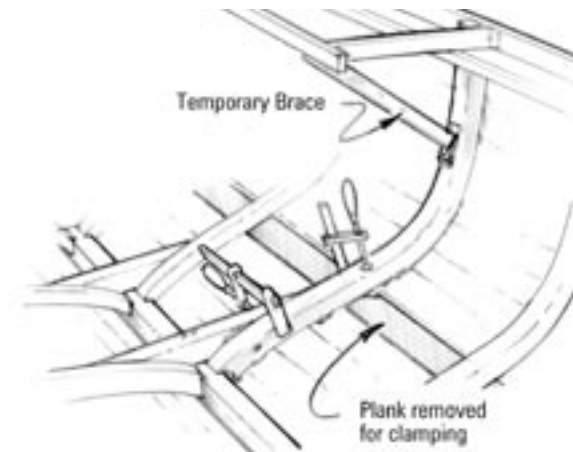

Figure 5-3 Install the new frame in the same position as the old frame. Braces or screws may be used to hold the frame until the epoxy cures.

5.3 Removing and replacing a damaged section

Damage to a frame is often limited to a small section or the frame may be too difficult to remove. It may be possible to replace only the damaged portion, restoring the strength of the frame whilst leaving the frame in position in the boat.

1. Cut out the damaged section of the existing frame. Trim the exposed ends to a minimum 8-to-1 scarf angle (*Figure 5-4*). The longer the scarf angle, the stronger the joint. When repairing hardwood or highly loaded frames, use a longer (12-to-1) scarf angle.

33 Structural Framework Repairs

2. Laminate a new piece slightly larger than the removed section, or carve a new section out of solid wood, using the same wood as the existing frame. Trim the new section to fit the size and shape of the void in the existing frame. Cut a matching scarf angle on each end of the frame section.
3. Prepare the surfaces for bonding. Trim the new piece and existing frame ends as necessary for a good fit.

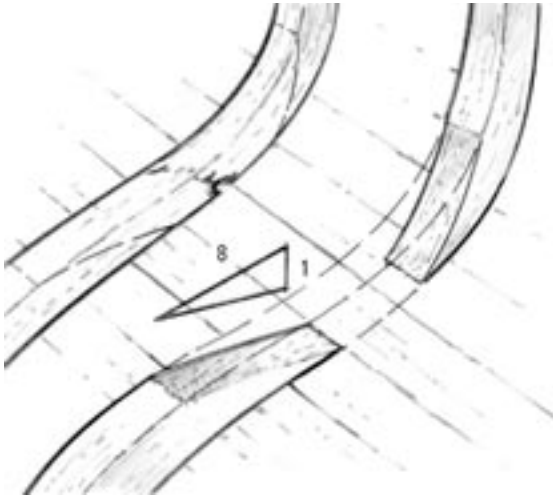

Figure 5-4 Cut out all of the damaged area, leaving at least an 8-to-1 bevel on the ends of the damaged frame.

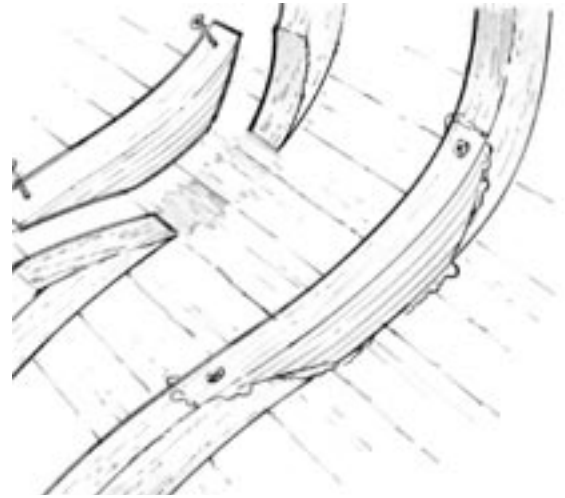

Figure 5-5 Bond in a new laminated or solid section trimmed to fill the void in the existing frame.

4. Install the new frame section (*Figure 5-5*). Wet out all contact surfaces of the new and existing frame ends. Apply a liberal amount of thickened epoxy/406 mix to one side of each contact area.
5. Clamp the section in position. Clean up excess epoxy before it cures. Remove clamps after epoxy cures thoroughly.

5.4 Installing sister frames or doublers

Sister frames are bonded alongside a damaged frame to restore the strength of the original. This method may not look as good as a replaced frame but it will save time, especially if the damaged frame is difficult to remove. Install sister frames as follows:

5

1. Laminate a full sister frame slightly longer than the existing frame and trim it to fit tight against the damaged section. Laminate a partial sister frame so that it will extend past each end of the damaged area twelve times the thickness of the frame (*Figure 5-6*). A sister frame may also be carved out of solid wood. Use the same wood as the existing frame.

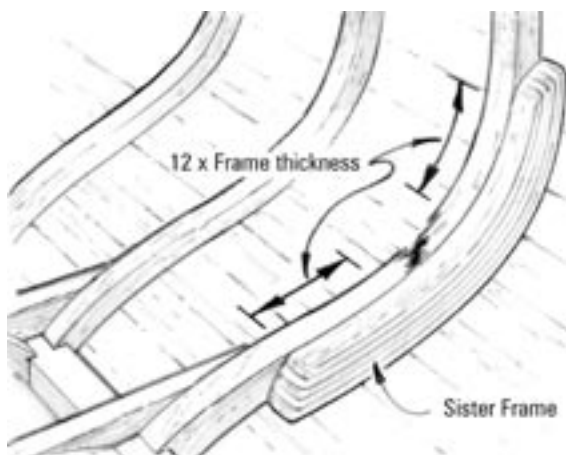

Figure 5-6 Laminate a partial sister frame longer than the damaged area.

2. Prepare the contact areas of both frames and the skin for bonding. Avoid bonding to the planking or plywood if it will be removed later.

3. Install the new frame section. Wet out all contact surfaces of the new and existing frames. Apply a liberal amount of thickened epoxy/406 blend to one side of each contact area.
4. Clamp the section in position. Clean up excess epoxy before it begins to cure. Remove clamps after epoxy cures thoroughly.

5.5 Joint repairs

If the framing is not damaged from rot or impact, it is still possible to bond the framing together to stiffen the structure and seal the joints against moisture. Remove as many frames as is possible and bond them in place using the standard bonding techniques in Section 3.4.2. Many of the frames that cannot be removed can still be bonded into place as follows:

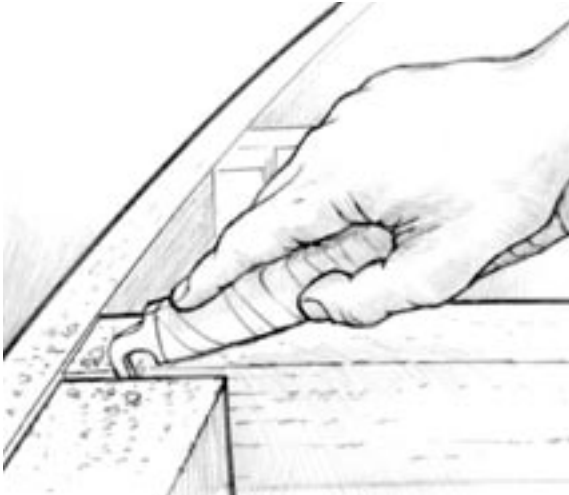

Figure 5-7 Use a scraping tool to clean out and abrade the inner joint surfaces.

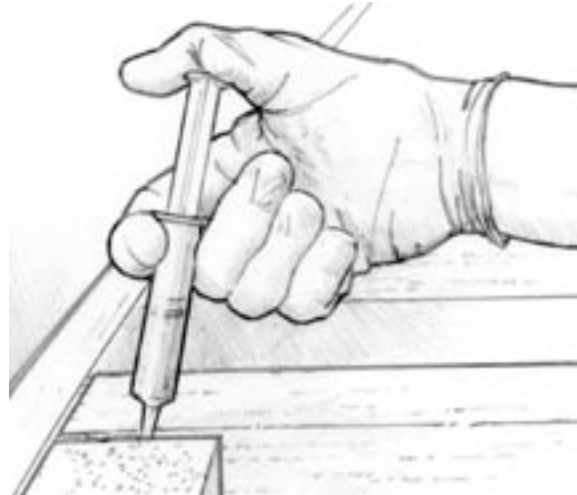

Figure 5-8 Inject epoxy as far as possible into the joint.

1. Support the boat in its proper shape before bonding any joints.
2. Open as many of the joints as possible, between frames and between frames and the outer skin. Loosen fasteners wherever possible. A small crow bar or wedge may be used to force the joint open temporarily. Use a saw blade or other sharp tool to scrape out old paint, varnish or dirt from the joints (*Figure 5-7*). Clean the inner joint surfaces to bare wood as much as possible.
3. Wet out the inner contact areas of the joint. Use a syringe, small brush or pipe cleaner to reach the middle of the joint.
4. Apply thickened epoxy to the contact area of the joint. Use a syringe to inject an epoxy/406 filler mix to the middle of the joint (*Figure 5-8*). A small plastic tube or straw taped to the spout of the syringe will extend the reach of the syringe into a tight area. Inject enough of the thickened mix so that a small amount will squeeze out when the joint is clamped together.
5. Clamp pieces in position until the epoxy cures. Tighten fasteners to draw the joint closed. Fasteners may be bonded in place for moisture protection and added strength (see Section 8).

5.6 Repairing garboards

The garboard is the plank which meets the keel or deadwood. It sometimes separates from the keel, allowing water to leak into the boat. If this leak recurs season after season even after the seams are thoroughly caulked, there may be a serious problem that needs attention. The wood keel may be pulling away from the floors (the wood timbers that tie the frames into the keel) or the floors may no longer be tied effectively to the frames.

To check for this:

- A. Inspect the area where the floors attach to the frames. Look for signs of movement between the floors and the frames (*Figure 5-9*).
- B. Inspect the area where the floors attach to the keel. Look for a gap between the floors and keel.

35 Structural Framework Repairs

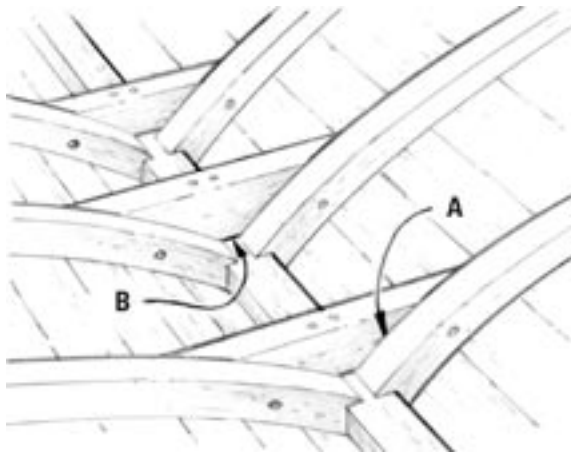

Figure 5-9 Inspect the floors, keel and frames for gaps or signs of movement.

5.6.1 Repairing floors

If gaps exist between the frame and floors or the floors and the keel, they will cause the garboard seam to open. The following repair procedures will correct the problem and permanently attach the floors to the frames and keel:

1. Remove the garboards and one or two additional planks from each side of the hull.
2. Prepare the keel, floors, and frames. Remove old paint or varnish and sand to bare wood. Dry the area thoroughly.
3. Cut new floors to fit opposite the old floors on the opposite side of the frames. They may be laminated or cut from solid stock.
4. Cut filler blocks that fit between the frames and between the new and old floors.
5. Bond the new floors and blocking to the keel and frames (*Figure 5-10*). Wet out all mating surfaces and end grain with resin/hardener mix. Apply thickened epoxy/406 filler. Clamp in position until epoxy cures. Allow the epoxy to cure thoroughly before removing clamps and proceeding with the next step.
6. Drill two vertical holes at each hull frame, through the blocking and at least 75mm into the keel. The diameter of the holes should be 3mm larger than the threaded rods selected for this repair.
7. Cut a piece of stainless or hot dipped galvanized threaded rod to match the depth of each hole. The threaded rod should be the same diameter as the original keel bolts.
8. Wet out one or two holes at a time with unthickened resin/hardener mix. Allow the epoxy to penetrate the end grain inside the hole.
9. Fill the wet-out holes half full of thickened epoxy using either 404 or 406 filler. Apply thickened epoxy to the threaded rod, filling the threads.
10. Push the coated rod to the bottom of the filled hole (*Figure 5-11*). Fill the holes to the top as necessary. Clean up excess epoxy before it cures.

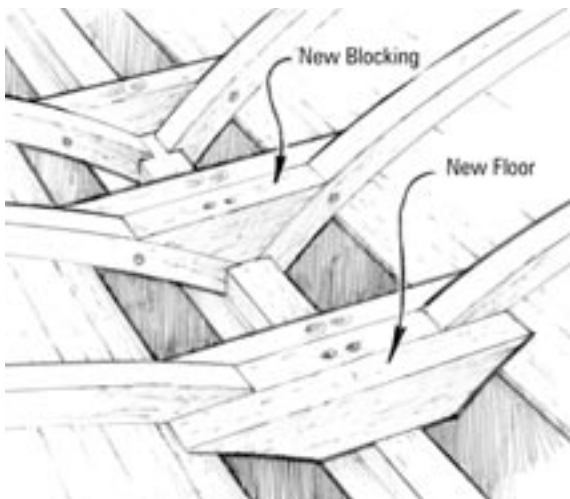

Figure 5-10 Bond new floors and blocking to the keels and frames.

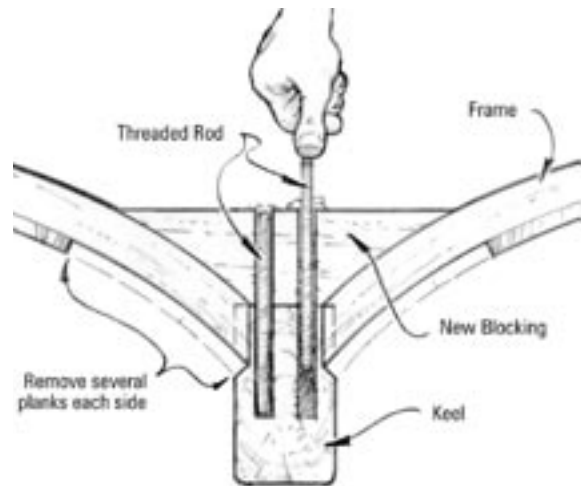

Figure 5-11 Bond threaded rod through the blocking and at least 75mm into the keel.

5.6.2 Reinstalling garboards

The keel, floors and frames are now permanently tied together with epoxy and threaded rods. With this completed, bond the planking removed earlier to the keel and frames:

1. Prepare the planking and frames for bonding. Remove all old paint or varnish. Sand the areas to be bonded to expose new wood fibre.
2. Dry fit the planks to the hull. Drill new holes for screws if the old ones do not align. Be sure to have enough clamps to draw the planks to the frames.
3. Wet out the screw holes (new and old) in the planks, frames and keel with resin/hardener mix, using a pipe cleaner or syringe. Wet out the edges and inside surface of the plank and the bonding areas of the keel and frames with resin/hardener mix.
4. Apply liberal amounts of thickened epoxy/406 filler to the mating surfaces of the keel and frames.

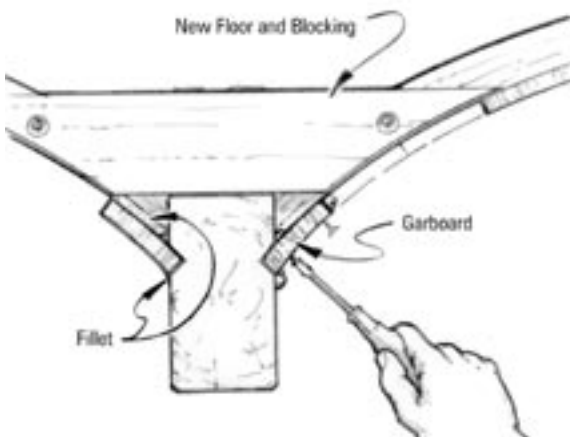

Figure 5-12 Bond the garboard back into position next to the keel.

5. Install the garboard with the original screws (*Figure 5-12*). Start at the middle and work toward both ends.
6. Form a fillet along the keel/garboard joint with the excess epoxy and form a fillet where the planking meets the frames.
7. Follow the same procedure and install the garboard on the opposite side of the keel.
8. Bond the remaining planks together, following procedures discussed in Section 6.

5.7 Keel repair

A keel is a major structural component and should require extra care and special investigation. Skegs, deadwood or fin keels can pose special problems. Deadwood can be inside or outside the planking line and typically has a fair number of exposed seams. It is generally not wise to encase the skeg or deadwood in a fibreglass/epoxy skin unless the joints in the structure have been previously stabilized. Worm damage may require replacement of the specific pieces.

If work is needed on the garboards, floors or frame heels, it is a good idea to examine the keel while the garboards are off. The joints and rabbets are prime locations for rot to start. These joints between the pieces of the deadwood or skegs are notorious places for leaks. The keel bolts or drifts passing from the ballast keel up through the deadwood, keel and floors allow water to pass up and into the hull.

Follow these procedures to repair the keel:

1. Remove the paint and/or any other coatings or coverings and allow the hull to dry out thoroughly (possibly schedule this work for the spring after the boat has had the winter to dry out).
2. When the seams are open and/or the keel or deadwood timbers have shrunk, clean out any old paint, caulking or debris. Make sure that the wood in the joints is dry.
3. Work epoxy thickened with 406 filler into the joints with a squeegee from one side until the epoxy comes out the other side. Clean up excess epoxy from the surface and allow the epoxy to cure.
4. Either coat the exterior of the skeg or deadwood with epoxy or cover it with a fibreglass/epoxy skin.

5.7.1 Keel bolt repair

If there has been leaking around the keel bolts, floor bolts, rudder tube or propeller shaft, follow these procedures:

1. Support and secure the boat and ballast keel.
2. Fabricate a deep engagement hole saw by first cutting the end off a hole saw of slightly larger diameter than the bolt to be repaired. Braze the hole saw teeth to the end of a pipe of the same diameter and long enough to chase the length of the longest keel bolt. Weld a piece of round stock into the other end of the pipe to serve as a bit for a drill chuck. If there are many bolts of many lengths to do, it may well be advisable to make several hole saws of different lengths (*Figure 5-13*).
3. After removing the nuts, washers or clinch rings, use the hole saw to chase down along the bolt. The typical hole saw will produce a clean 3mm annulus around the bolt.

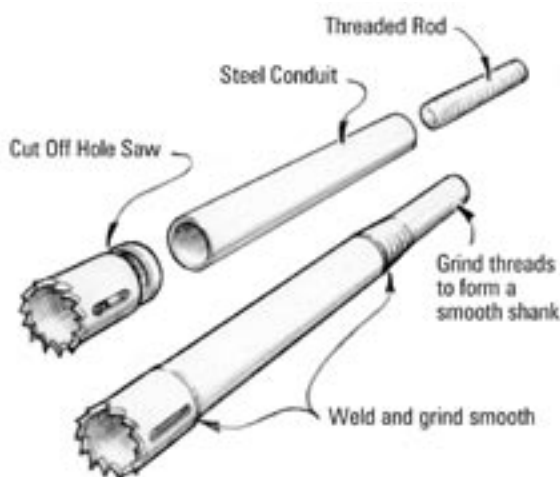

Figure 5-13 A custom keel bolt saw can be built from a pipe section and a standard hole saw.

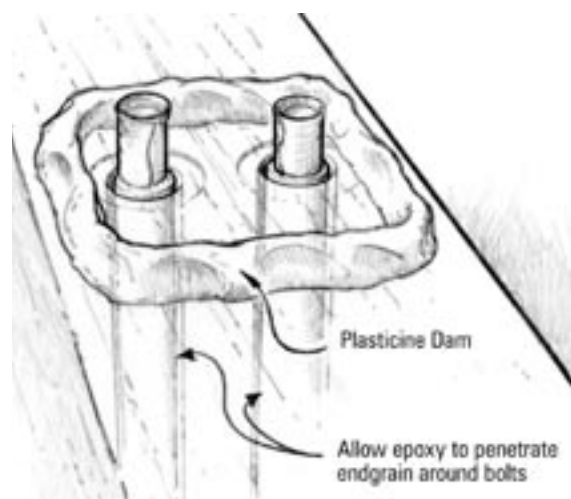

Figure 5-14 Build an epoxy reservoir around each keel bolt.

4. After blowing out the dust and shavings, wrap duct tape around the bolt threads and construct a 6mm high dam around the bolt hole with plasticine (*Figure 5-14*).
5. Overfill the hole with epoxy. Keep the plasticine dam full as the epoxy soaks into the end grain in the hole.
6. After the epoxy has cured, sand the surface smooth, remove the protective tape and replace the washers and nuts.
7. Contact Wessex Resins for more specific discussion of repairing larger keels.

Section 6

6 Hull and Deck Planking Repairs

This section is a guide for the repair of the outer skin of wooden boats. The skin covering the deck and hull framework of wooden boats can generally be divided into two categories: planking and plywood. Planking is the older, traditional method of covering hulls and decks and is more susceptible to flexing and leaks than plywood. Modern adhesives have made plywood a more common and practical skin for wooden structures. The procedures in this section address the problems and repairs for the most common types of skins. Select the procedure or combination of procedures that suits the situation in hand.

6.1 Carvel planked hulls and laid plank decks

For centuries, carvel planking and laid plank decking were the only methods of enclosing a boat. Carvel planking and laid plank decking are essentially the same method, in which many individual boards are laid edge to edge, fastened to each frame and caulked. Eventually the structure loosens up, the caulking breaks down and the planking becomes a constant source for leaks requiring endless maintenance. While carvel hull planking and laid plank decks vary in the size and placement of the planks, they are similar in function and can be repaired with the same techniques.

As mentioned in Section 1.4.2, the ideal reconstruction would be to remove the planking, clean and strip it of paint, and re-bond it to the framing timbers. If this can be achieved, it will eliminate places where moisture can become trapped and will allow both the inside and the outside of the hull to be coated with epoxy to encapsulate the structure. Remember, the boat can only be encapsulated with epoxy if all the surfaces, especially the contact surfaces of joints, can be coated.

If, however, the planks are not to be removed, the best solution to remedy leaks and loss of stiffness is to (1) clean out the seams and (2) bond the planks together with epoxy. This seals the seams permanently and eliminates movement between planks. A strong bond between all the planks will result in a rigid monocoque structure.

6.1.1 Cleaning out the seams

Ensuring that a good clean bonding surface is prepared on each plank edge is the first step. Use a circular saw, a router, a chisel and hammer, or a sharpened scraper to clean all the old caulking material from the joint and expose clean fresh wood for bonding on the facing edge of each plank. One tool may work better than another in a given situation, but a circular saw is usually the most effective way to mill out the seam accurately.

1. Dry the hull thoroughly before beginning. This allows the seams to open to their widest and stabilizes the size and shape of all the pieces.
2. Tack a batten to the hull to act as a guide for the saw. The batten should be parallel to the seam so the blade will follow the centre of each seam exactly.
3. Select a blade or reset the teeth wide enough to shave the edges of both planks facing the seam. Use a pair of pliers to bend the teeth for more set. The seam width may vary, but the cut should be at least 4.5mm wide. If the seams have opened very wide after drying, two passes with the saw may be necessary to shave both planks.
4. Set the depth of the cut to 1.5mm less than the thickness of the plank. Leave just enough material at the back of the seam to prevent epoxy from passing through to the inside.
5. Clean out each seam by running the saw along the batten (*Figure 6-1*). Check the depth and width of the cut. Clean out the butt joints at the ends of the plank. Chisel a shallow bevel on the end of the planks (6mm deep x 12mm back from the edge) (*Figure 6-2*).

39 Hull and Deck Planking Repairs

A router with a straight fluted bit will work effectively to clean out seams. Select a bit wide enough to shave both planks. The router will get into tighter places than the circular saw, but the bits dull quickly, often break and are expensive to replace.

A chisel can be used in tight spots to carve a “V” groove where a saw or router will not work. A scraping or “reefing” tool for cleaning out seams can be made from a mill file as shown in *Appendix C* or invent your own tool or method for cleaning the seams. Remember, the object is to clean out the old caulk and expose clean wood on the facing edge of each plank for good bonding.

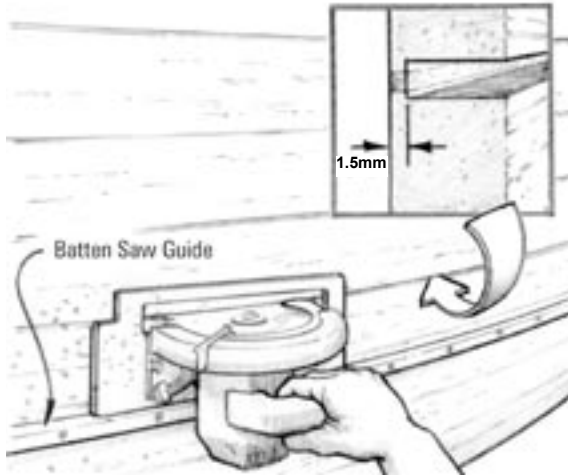

Figure 6-1 Use a circular saw to clean out plank seams.

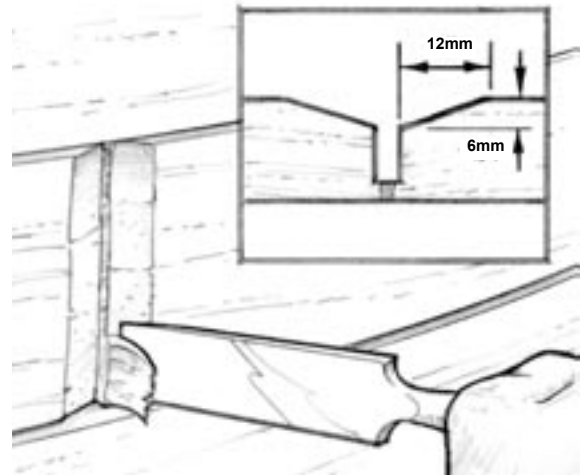

Figure 6-2 Cut a bevel on the end of each plank.

6.1.2 Filling the seams with wood

After machining a clean gap between two planks, bond a spline of suitable wood into the gap. **Remember!** Support the hull in its correct shape before bonding. The shape of the hull will be permanently set once the planks are bonded.

1. Prepare the splines. Cut them from stock that is the same species and thickness as the planking. Rip the splines on a table saw, with the blade set at a 5° angle. Flip the stock end for end after each pass so that each spline will have a 10° taper in cross section. Set the width of the cut so that the wide end of the taper is the same width as the seam gap. It should fit snugly when pushed into the gap, just as the narrow end hits the bottom of the gap. The splines can be any convenient length for easy handling. Cut a 45° scarf on the ends of each spline.
2. Wet out an equal length of opened seams and splines with resin/hardener mix. Use a glue brush or swab to wet out the seam. Use a foam roller, cut to a narrow width, to wet out the splines.

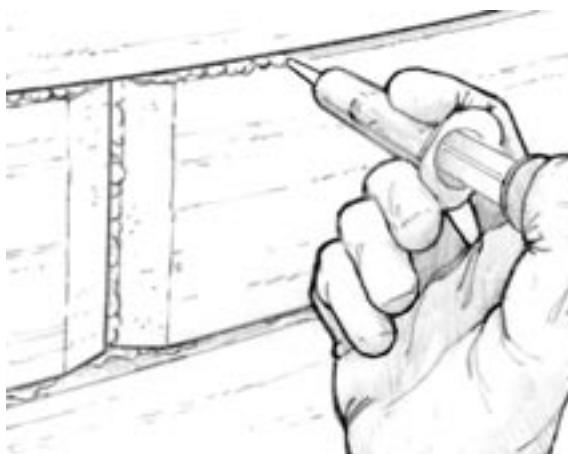

Figure 6-3 Inject epoxy into the wet-out seam.

3. Apply a bead of epoxy/403 or 406 to mayonnaise consistency in the seam. Use a syringe to fill the gap with enough epoxy so that a small amount will squeeze out when the splines are pushed in (*Figure 6-3*).
4. Push the spline, previously wetted with epoxy, into the seam (*Figure 6-4*). The taper on the spline should force epoxy to the sides, making good contact with the spline and edges of the planks. The spline should fit snugly in the seam with hand pressure after a small amount of epoxy squeezes out

of the joint. Staple the spline if necessary to hold it in position.

5. Clean up excess epoxy. Use a sharpened mixing stick to scrape up excess epoxy before it cures. Station a helper inside the boat or check the inside frequently to clean any epoxy leaking through the planking.
6. After the epoxy has cured thoroughly, remove the excess portion of the spline with a plane followed by coarse sandpaper (*Figure 6-5*). Fibreglass cloth is often applied to provide additional reinforcing and abrasion resistance. Follow the coating/finishing procedures in Section 3.4.



Figure 6-4 Push the wet-out spline into the seam.

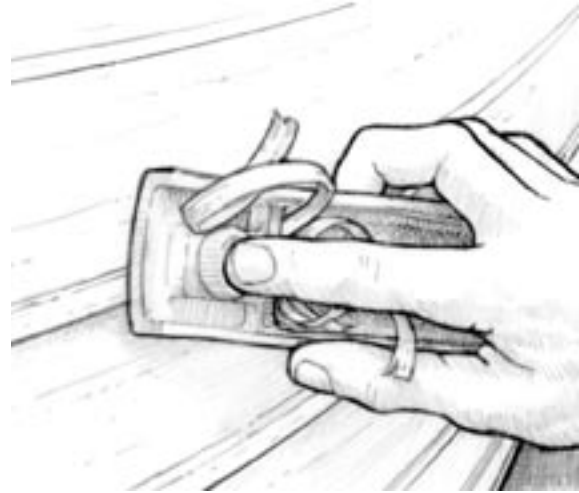

Figure 6-5 Use a plane to remove the excess spline and a sander to fair the surface after the epoxy has cured.

6.1.3 Filling the seams with epoxy.

A quicker but more expensive way of bonding the seams is to fill the entire gap with thickened epoxy (epoxy is more expensive than wood by volume). This method is more practical on seams that are too curved or tight for a spline.

1. Open the seam as before. The gaps do not have to be a particular width, as long as fresh wood is exposed on each plank edge.
2. Wet out the gap with resin/hardener mix.
3. Fill the seam with thickened epoxy/403 (mayonnaise consistency). Note: 403 filler will leave an off-white coloured seam, which will not matter if planning to paint the surface. If a clear finish is required, we suggest using 405 Filleting Blend or a colouring agent mixed with the epoxy to match the planking colour. (See Section 8 for information on finishing). Large syringes or caulking tubes are convenient to inject the thickened epoxy into the seams. Smooth the mix flush with the surface and remove excess epoxy before it cures. Check the inside for leaks and clean any excess epoxy before it cures.
4. Sand the surface fair after the epoxy cures thoroughly. Fill any remaining low areas with epoxy/low-density filler blend. Follow the coating/finishing procedures in Section 3.4.

6.1.4 Repairing damaged planks in place

If repairing or replacing a lot of planks, it is best to repair individual planks and small areas completely before going on to other areas. The hull may be seriously weakened and lose its shape if too many planks are removed at one time. Scarf joints or butt joints can be used in repairing damaged sections of planks without removing the entire plank. Support the hull in its proper shape before bonding.

Scarf joint method

To repair damaged sections of planks using scarf joints:

1. Remove the damaged part of the plank using a circular saw, hand saw or chisel.
2. Bevel each end of the plank opening with an 8-to-1 scarf.
3. Cut a piece of wood to fit the opening. Match the 8-to-1 bevel on each end (*Figure 6-6*). Make the new piece of wood slightly thicker than the original planking. Excess material inside or outside the hull can be planed off after the glue has cured.

41 Hull and Deck Planking Repairs

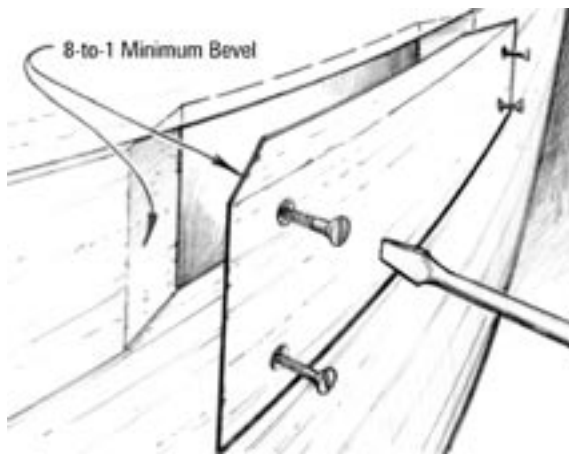

Figure 6-6 Replace a section of plank using scarf joints.

4. Wet out the mating surfaces with resin/hardener mix. Recoat the scarfed surfaces as necessary until the end grain is fully saturated.
5. To one side of each bonding area apply thickened epoxy filled with either 403 or 406 to peanut butter consistency.
6. Clamp the scarfed section in place with temporary screws or staples until the epoxy has cured. Corrosion-resistant screws can be left if the pilot holes were wet out with epoxy.
7. Remove clamps and fair the surface after the epoxy has cured thoroughly. Follow the coating/finishing procedures in Section 3.4.

Butt joint method

The butt joint is an alternative to the scarf joint for repairing damaged planks in place. Although not as strong as the scarf, it is considerably easier to produce. Butt joints should be staggered (adjacent planks should not end at the same place).

To repair a damaged plank section using butt joints:

1. Remove the damaged portion of the plank using a circular saw, hand saw, saber saw or chisel.
2. Cut a replacement piece of wood for the opening and a piece for a backing plate (*Figure 6-7*). A backing plate will be required behind each butt joint unless the joint falls on a frame. When the repair section falls between frames, the backing plate should run from frame to frame. When replacing longer sections of planking, a backing plate is only required at the ends.

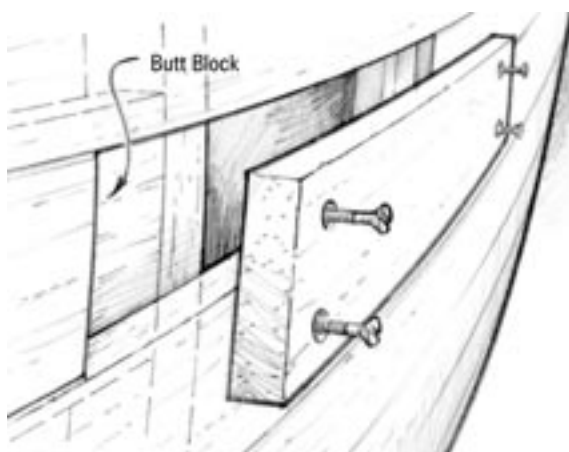

Figure 6-7 Replace a section of plank using butt joints.

3. Wet out all mating surfaces with resin/hardener mix.
4. Apply thickened epoxy filled with either 403 or 406 to a peanut butter consistency to the mating surfaces (including the surface of the backing plate facing the plank).
5. Install the backing plate(s) to the back of the planking. Temporarily clamp the backer in position with screws, staples or nails.
6. Install the new plank section. Clamp the section in position with screws, staples or nails. Fill remaining

openings in seams with thickened epoxy.

7. Remove clamps and fair the surface after the epoxy has cured thoroughly. Follow the coating/finishing procedures in Section 3.4.

6.1.5 Double Planking

Repairs to double planked boats involve removing the outer layer of planking, repairing the inner layer following the procedures already described in Section 6.1, and then replacing the outer layer of planks. Removing both layers of planking is desirable because it allows a thorough examination of the planks and enables the planks to be sealed completely in epoxy. If wishing to coat the inside of the hull with epoxy, remove both layers of planking, clean and strip the timber of paint and re-bond the planks to the framing timbers.

Important: only encapsulate the boat with epoxy if all the surfaces, especially the contact surfaces of joints, can be coated.

To repair double planking:

1. Carefully label the outer layer of planking for position and remove it.
2. Decide if the planks are worth saving. If so, clean, dry, repair and sand the planks.
3. Remove and discard the canvas between the layers of planking.
4. Follow the procedures described in Section 6.1.1 - 6.1.4 to clean out the seams and bond the layer of planking still on the hull.
5. Bond the second layer of planking, following techniques discussed in Section 3.4.2. Use screws in the old screw holes to hold the planks in place while the epoxy cures.

6.1.6 Repairing Tongue and Groove Deck Planking

The methods described previously are also applicable to tongue and groove deck planking.

1. Clean the seams to the tongue.
2. If access is possible and the tongue is loose or broken, tape the underside of the seams.
3. Force thickened epoxy filled with either 403 or 406 to a mayonnaise consistency into the seams as thoroughly as possible. This mix, forced with a 125mm wide putty knife, can flow about the tongue and groove joint and into the underside seam, thereby achieving a complete bond of the mating planks.

6.2 Clinker (Lapstrake) planked hulls

Clinker (or lapstrake), like carvel planking, is composed of a single layer of planks thin enough to bend to the shape of the hull. However, each plank (or strake) overlaps the face of the preceding plank rather than butting the edge. Wooden clinker hulls often have trouble with the lap fasteners working seams open, causing leaks. The most successful repair is to clean out the lapped seams and bond the planks together with epoxy. It will be very helpful to work on the boat upside down if it is small enough to turn over.

Repair clinker hulls as follows:

1. Remove all paint or old finish on the outside of the hull.
2. Scrape the old paint and caulk out of all the seams. Use a custom scraping tool to clean out and abrade the plank mating surfaces down to bare wood (*Figure 6-8*). A file with the end bent and sharpened or a hacksaw blade makes an excellent seam scraper (*see Appendix C*). Allow the wood to dry thoroughly if it has not already dried. Support the hull in its proper shape before bonding.
3. There is typically a transition from the lap to a rabbet where the planking laps run into the stem or transom. This allows the planks to lie flush with each other and fair with the stem. When cleaning out the laps, pay attention to this transition zone. It may be necessary to remove fasteners at the ends of the planks and open them slightly to clean out the seams and the rabbets.

43 Hull and Deck Planking Repairs

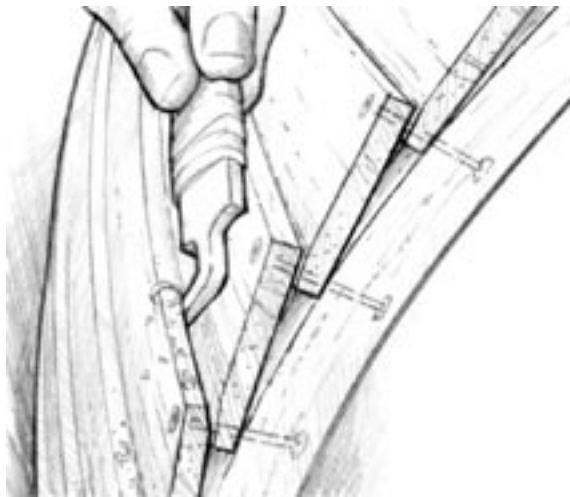

Figure 6-8 Clean out the seams with a scraper.



Figure 6-9 Fill the wet-out seam with thickened epoxy.

4. Wet out the opened seam surfaces with resin/hardener mix. Work epoxy into the seam as deeply as possible with a disposable brush or syringe.
5. Apply thickened epoxy filled with either 403 or 406 (peanut butter consistency) into the opened seams. Use a squeegee to force the thickened epoxy into the seam as far as possible (Figure 6-9). Check inside for epoxy leaking through the planks. Clean excess epoxy before it cures.
6. Shape the thickened epoxy at the inside corner of the seam to a square inside corner or a cove-shaped fillet. A fillet increases the bonding area around the seam and provides more protection to the edge of each plank. For more details on fillets see Section 3.4.3.
7. Sand the seams and plank surfaces fair after the epoxy has cured thoroughly. Fill and fair any remaining voids with an epoxy/low-density blend. Follow the coating/finishing procedures in Section 3.4.

6.3 Plywood

Marine Plywood has an excellent strength to weight ratio and is stable both along and across the board making it an ideal material for boat building and repair. Various types and qualities are available on the market today and generally price is a good indicator of quality.

It is important to ensure the plywood is marked BS1088 and has the country of origin stated to comply with the BS1088 regulations. Some boards will be manufactured by mills with Lloyds Type Certification, or other Certifications which are good indicators of quality, but should not be considered guarantees of quality as they refer to the manufacturer's management and quality systems.

Cheaper marine plywood, often made in the Far East or Brazil is good for fitting out work, but will often have thin face veneers and thick central laminates. This means any fault in a centre veneer will affect a greater proportion of the thickness of the board than in a multi laminate panel. If the application is structural it is better to opt for a multi-laminate panel. Okoume (Gaboon) makes a very good and lightweight marine panel and is excellent for use with epoxy. Where heavy stress exists, or the panels are to be used in a tropical environment, a heavier and more durable plywood should be used made from Mahogany or Sapele.

Our experience shows that the quality of the timber used and the construction of the laminates vary considerably and we suggest contacting a reputable timber merchant who specialises in marine plywoods (such as Robbins Timber in Bristol). Such companies will be able to advise on the best type of marine plywood for the intended application.

6.3.1 Rebuilding a plywood joint

If the seam between plywood sheets has deteriorated, clean out the joint, seal the edges with epoxy and reinforce the joint with fibreglass tape applied with epoxy. The seam may be on a flat surface or at an edge or chine.

Rebuild a plywood joint as follows:

1. Clean out the seam by running a circular saw or scraping tool along the seam. Set the depth of the saw cut to the full thickness of the plywood when the seam runs along a frame. Set the width of the blade to shave the edges of both sheets of plywood at the joint and expose fresh wood on each edge. Remove any fasteners in the way of the cut. Let the wood dry thoroughly if necessary.
2. Drive the fasteners deeper at the joint to allow for a valley to be sanded along the joint for the placement of one or more layers of fibreglass tape.
3. Sand a 100mm to 125mm wide valley along the joint with a disc sander to allow the layer(s) of tape to lie below the surface. Make the depression about 0.75mm deep for each layer of 175g/m² (6 oz/yd²) fibreglass tape that will fill the joint. Use the sander or a chisel to remove any additional damaged or rotted plywood around the joint. At an edge or chine, use the sander or a router with a roundover bit to round the corner. A 6mm to 9mm radius will allow the glass tape to lie flat on the surface (*Figure 6-10*).
4. Wet out the seam and sanded area with resin/hardener mix. Recoat the seam with epoxy as necessary as it is absorbed into the end grain of the plywood. Inject or work epoxy between any delaminated veneers that are still sound.
5. Apply thickened epoxy filled with either 403 or 406 to a mayonnaise consistency into the pre-wetted seam. Use a plastic squeegee to force the thickened epoxy into the wet-out seam and smooth the excess mix along the joint. Work the thickened epoxy into any voids and between delaminated veneers previously wetted out with resin/hardener mix.
6. Apply a layer of fibreglass tape in the depression along the joint (*Figure 6-11*). Use the squeegee to work epoxy into the fabric and remove the excess. Apply additional layers, if desired, in the same manner. Place new layers 12mm to either side of the previous layer so the edges do not fall directly on top of each other. For details on applying fibreglass cloth, see Section 3.4.6.
7. Apply thickened epoxy filled with either 407 or 410 low-density filler to a peanut butter consistency to the joint. Use a squeegee to trowel on and shape the thickened epoxy slightly higher than the plywood surface (Section 3.4.5). Allow to cure thoroughly and sand fair.

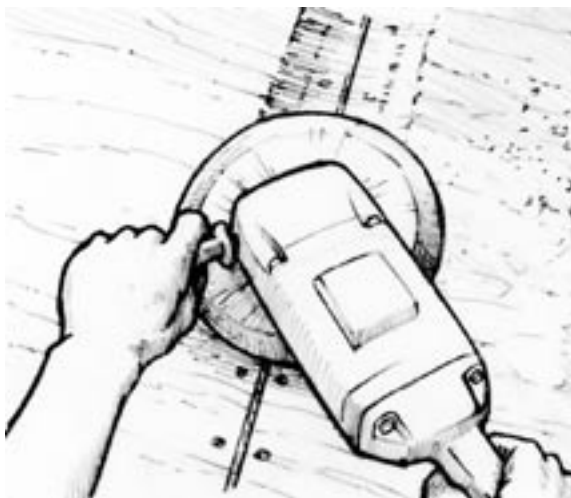

Figure 6-10 Sand a valley along the joint to allow for fibreglass tape.

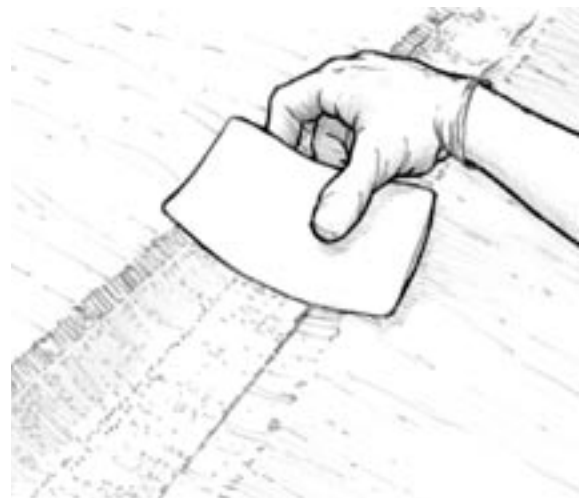

Figure 6-11 Apply fibreglass tape over the prepared joint.

6.3.2 Replacing damaged plywood sections.

Sections of plywood panels may suffer from impact or dry rot damage and can be repaired without replacing the whole panel. The damaged section can be cut out and a replacement section bonded in without losing any panel strength.

Replace small plywood panel sections as follows:

1. Cut the damaged section out of the panel. Use a circular saw or reciprocating saw to cut the smallest square or rectangle that encloses the damage. Check the extent of damage on the interior of the panel.

45 Hull and Deck Planking Repairs

2. Scarf or step the edges of the opening.
 - a. Grind a scarf on the edges with a disc sander (*Figure 6-12*). Grind a minimum 8-to-1 bevel back from the edges of the opening. (If the panel plywood is 12mm thick, the bevel should extend at least 100mm from the edge of the hole on each side.)
 - b. Mill a step on the edges of the hole with a router. Use a straight fluted bit to machine a step or steps in the panel round the opening. The width of each step should be eight times the step thickness. Steps are convenient when laminating several layers of thinner plywood to equal the thickness of the damaged panel. Make each step equal to the thickness of one replacement layer.
3. Fabricate the replacement panel using the same or equivalent plywood as the original. Cut the panel to the outside dimensions of the bevel or step.
 - a. Use the disc sander to machine a bevel on the inside edge of the replacement panel to match the bevel on the opening. Dry fit the new panel to fit slightly below the existing surface (*Figure 6-13*).
 - b. Use the router with the straight fluted bit to machine steps in the edges of the replacement panel to match the steps around the opening. If multiple layers of plywood are to be used, cut one layer to the dimension of each step. Dry fit the new panel to fit slightly below the existing surface.
4. Wet out the bonding area of the panels with resin/hardener mix. Recoat the end grain as necessary. (Plywood end grain will absorb a lot of epoxy.)
5. Apply thickened epoxy filled with either 403 or 406 to a mayonnaise consistency to the bonding area of the new panel. Apply enough thickened epoxy so that a small amount will squeeze out when the new panel is pushed into the dry-fit position.

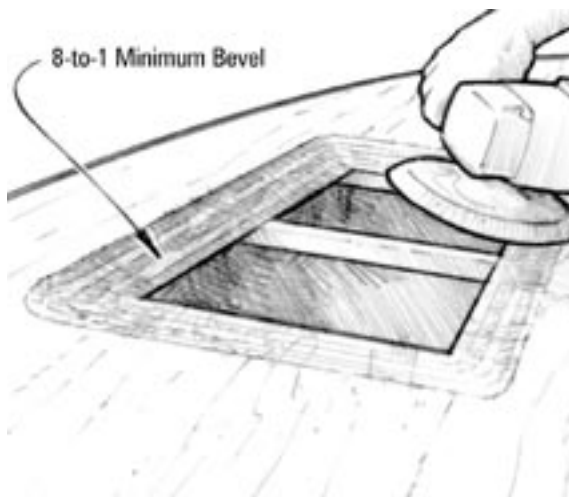

Figure 6-12 Cut out the damaged area and grind a minimum 8-to-1 bevel on all sides of the opening.

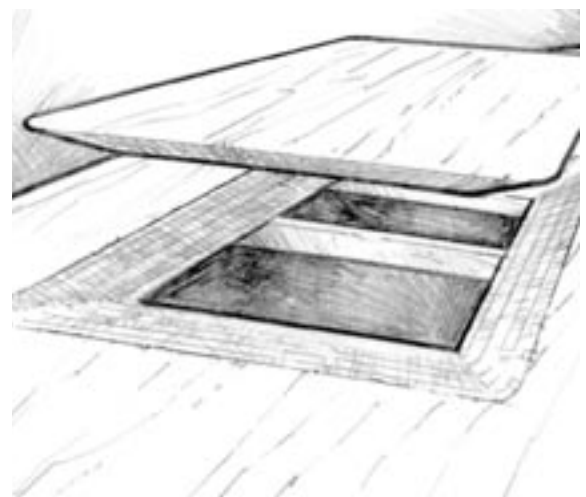

Figure 6-13 Clamp a new repair patch in position with staples or screws.

6

6. Clamp the new panel in position with temporary staples or screws (*Figure 6-13*). Permanent fasteners should be non-corroding and pilot holes should be wet out with epoxy. Clean up excess epoxy before it cures. Allow the epoxy to cure thoroughly before removing clamps. Bond multiple thinner layers in place, one at a time, following the same procedure. Use a thinner epoxy/filler blend on the flat bonding areas between the layers.
7. Sand the surface and fill low areas with epoxy filled with either 407 or 410 low-density filler to a peanut butter consistency. Use a squeegee to apply the thickened epoxy, slightly overfilling low areas on the surface. Allow the mixture to cure thoroughly before fairing.

6.3.3 Replacing/installing plywood

It is possible to install new plywood over exposed frames or over existing hull or deck surfaces. Plywood used as the primary skin (bonded directly to the frames) may be laid out with scarfed joints falling directly over the frames or with butt joints over backing plates between the frames. Scarfed joints offer a cleaner appearance from the interior. The frame spacing and size of the boat determine the thickness of the plywood. The amount of compounding determines whether the total thickness can be applied in one layer or in multiple layers. Apply thinner plywood in multiple layers if one layer is too thick to bend over a curved surface.

Apply a primary plywood skin as follows:

1. Prepare plywood panels, scarf joints and beam surfaces. Plan both the panel layout and order of assembly so that the scarf on the following sheet lies over the scarf on the previous sheet (*Figure 6-14*).
2. Wet out the bonding surfaces of the plywood and frames. Wet out scarfs on the ends of adjoining sheets.
3. Apply a coat of thickened epoxy/406 blend to the bonding surfaces of the frame and the scarf of the previous sheet.
4. Lay the sheet in position over the frames. Align the scarf joint to avoid overlapping (*Figure 6-14*).
5. Clamp the sheet temporarily with drywall screws or staples. Use enough fasteners to clamp the sheet evenly. The epoxy mixture should squeeze out of the joints, assuring good adhesive contact. Station someone inside to clean excess epoxy at the frames and joints. The excess can be scraped clean or shaped into a fillet before it begins to cure.
6. Repeat the process with the remaining sheets. Allow the joints to cure thoroughly before removing temporary fasteners.
7. Sand the joints and fair the surface before adding another layer of plywood, glass cloth (3.4.6) or finishing (3.4.8).

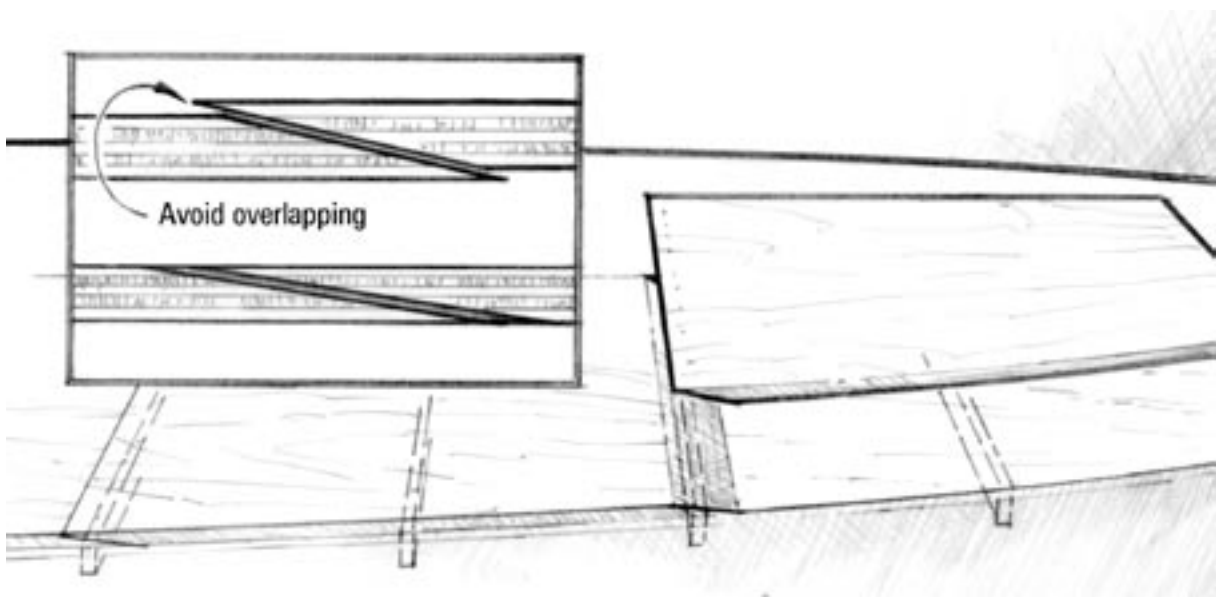

Figure 6-14 Plan the panel layout so that scarf joints will fall over beams for better clamping.

6.3.4 Applying plywood over existing skins

When laminating an additional layer of plywood over an existing hull or deck, it is not necessary to scarf joints or place joints directly over frames because of the large bonding area. Restore existing plywood to sound condition before laminating new sheets onto the old structure.

Laminate new plywood over an existing deck or hull as follows:

1. Re-bond delaminated layers of plywood, after drying thoroughly. Drill a pattern of 3mm holes (approximately 25mm apart) in the delaminated area. Use a syringe to inject a slightly thickened epoxy/406 mix in the holes to wet out the delaminated area. Use staples or screws to clamp the layers together until the epoxy cures. When the epoxy has cured thoroughly, proceed with Step 2.
2. Sand the surface fair to clean, bare wood. Remove all old finishes and contaminants.
3. Open existing joints with a scraper, saw or router and fill the joints with epoxy. Repair with glass tape, if necessary, as suggested in Section 6.3.1.
4. Cut out severely damaged areas and scarf in new plywood, if necessary, as suggested in Section 6.3.2.
5. Plan the layout of the new plywood sheets to avoid new joints falling over existing joints.
6. Apply an epoxy/406 mix to both bonding surfaces with a roller. Thicken the mixture to a ketchup consistency to allow some penetration and still bridge any gaps between the surfaces. If the surface is rough or uneven, thicken the epoxy/filler blend to a mayonnaise consistency and apply with a notched spreader.

47 Hull and Deck Planking Repairs

7. Clamp the sheet in position with an even pattern of temporary screws or staples. Clean up excess epoxy at the joints. Repeat the procedure with each sheet. Allow the epoxy to cure thoroughly before removing temporary fasteners.
8. Sand the surface fair before final finishing.

6.4 Moulded or laminated veneer repairs

Another option for skin covering uses strips of thin veneer instead of sheets of plywood. Laminated boats were and are built by bonding layers of thin veneers together over curved forms; in effect building a sheet of plywood in the shape of a boat. This technique has produced lightweight rigid hulls that are not limited to the flat surfaces and hard chines of plywood boats. Using veneers for skin repairs offers the advantage of being able to conform to any curved shape, especially compound curves. This advantage can be used for repairs in several ways. Veneers can be used to patch small sections of laminated hulls that are too curved for a plywood patch. On a larger scale, laminating layers of veneer over an existing plywood or carvel planked hull is an excellent method of adding a great deal of stiffness to a hull or deck without removing the existing skin. More detailed information about laminating veneers as a building technique can be found in the book **“THE GOUGEON BROTHERS ON BOAT CONSTRUCTION”**.



Figure 6-15 Remove the damaged section.



Figure 6-16 Bevel the edges and fasten temporary stringers to the back of the opening.



Figure 6-17 Cover the stringers with plastic to prevent bonding.

6.4.1 Laminating a curved patch in place

Laminating a patch to repair a moulded panel combines two procedures already covered: repairing damaged plywood sections and laminating frames. Laminating a curved panel section in a large damaged area requires temporary back-up stringers to act as a jig.

Laminate the patch in place as follows:

1. Remove the damaged section of the panel. Define the area of damage. Use a circular saw or reciprocating saw to cut the smallest square or rectangle that removes all damage (*Figure 6-15*). Check the extent of damage on the interior of the panel as well.
2. Scarf the edges of the opening with a disc sander. Grind a minimum 8-to-1 bevel back from the edges of the opening. (If, for example, the panel plywood is 12mm thick, the bevel should extend at least 100mm from the edge of the hole on each side.)
3. Fasten temporary stringers to the back side of the opening with screws (*Figure 6-16*). The stringers should be strong enough and spaced closely enough to hold the veneers to the proper shape. Cover the stringers with plastic to prevent bonding (*Figure 6-17*).
4. Staple the first layer of veneers over the stringers. Run the veneers diagonally, approximately 35° from vertical. Scarf the ends of the veneers to match the scarf on the edge of the opening. Bond these first layer veneers only where the scarfs make contact, using the bonding procedure in Section 3.4.2. Use 403 or 406 filler to thicken the epoxy to a mayonnaise consistency.



Figure 6-18 Bond the second layer in the opposite diagonal to the first layer.

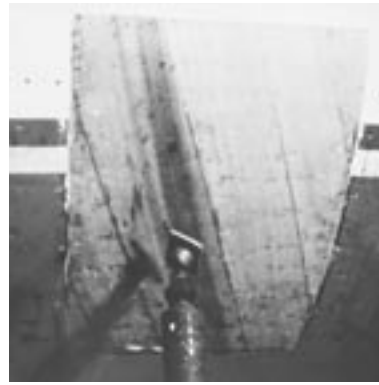

Figure 6-19 Continue until all the layers are completed, matching the skin thickness.

5. Bond the second layer of veneers after the first layer has reached a partial cure, but it is necessary to sand if full cure has been reached (*Figure 6-18*). Run the veneers diagonally in the opposite direction, about 35° from vertical. Remove the staples only in the area under the veneer being bonded. Coat the face of the new veneer and the contact area of the first layer including both scarfs. Staple through the veneers into the stringers and at the scarfs as necessary to hold the veneers flat.
6. Continue until all the veneers are in place and the original skin thickness has been matched (*Figure 6-19*). Remove the staples in the previous layer as each new veneer is bonded and, in this way, previous layers of veneer will stay in place even though the epoxy has not thoroughly cured. This will allow the bonding of several layers of veneers in one continuous operation. Be sure the staples are long enough to provide clamping pressure by penetrating to the stringers or veneers that have cured fully. Allow the final layer to cure thoroughly before removing staples, fairing and final finishing.

6.4.2 Laminating a patch away from the damaged area

A panel section can also be repaired by using the existing skin as a form to laminate a patch panel and subsequently bonding in place the pre-formed patch in one piece. The size of the patch should include the damaged area plus an 8-to-1 scarf beyond the damaged area. Tape a sheet of plastic over and beyond the area to be used as a mould surface. An adjacent area that is curved slightly more than the damaged area is an ideal mould surface because it compensates for veneer springback during moulding (*Figure 6-20*). After laminating the appropriate number of veneers to equal the size and thickness of the damaged section (plus scarf), prepare matching scarfs on the damaged area and the patch. Then bond the patch into place using the procedure described previously in Section 6.3.2.

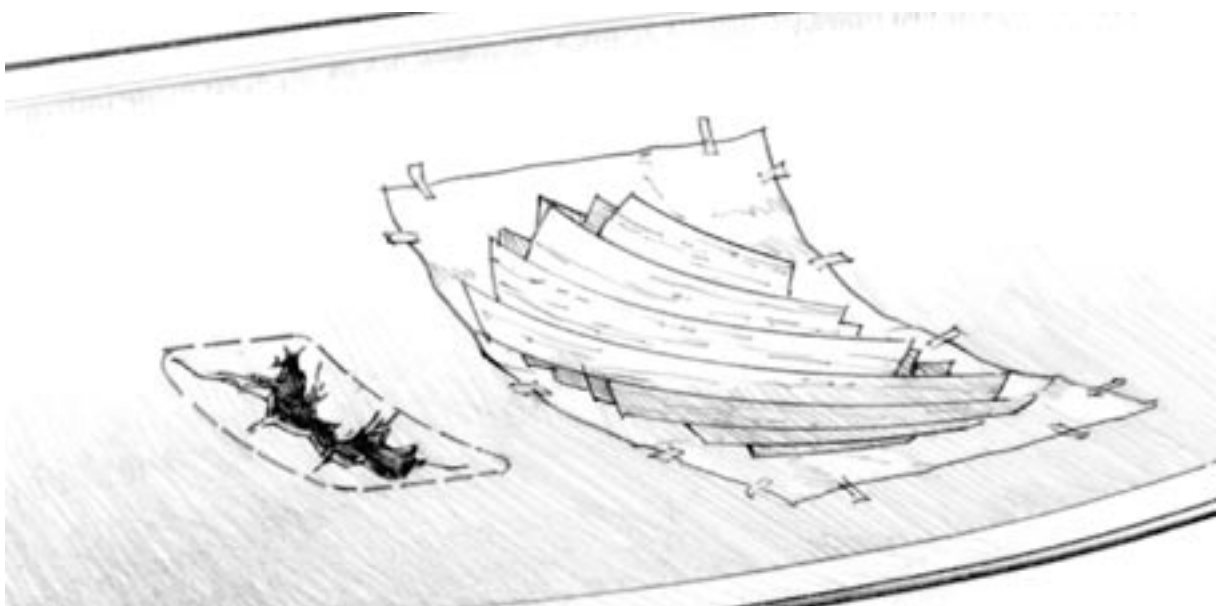

Figure 6-20 Laminate a replacement panel using the surface next to the damaged area as a mould.

6.4.3 Laminating a new skin over an old skin.

The technique of laminating one or more veneers over an existing hull has breathed new life into many boats that otherwise would have been given up as a lost cause. The thickness and species of the new skin depends on how much strength is left in the old skin. If the hull can be supported in the proper shape, the new skin could entirely replace the function of the old skin. After the total thickness and type of wood has been established, determine the thickness and number of layers of veneer. As a rule, use the thickest and fewest layers of veneers that can bend and clamp to the tightest curves on the hull. Bonding all the seams of a planked hull before adding veneers to the hull will add stiffness and reduce the total thickness of veneers required (see Section 6.1).

Laminate veneers to an existing skin as follows:

1. Prepare the existing hull for bonding. Be sure the surface is clean, dry and sanded. Support the hull in its proper shape. Fill and fair low areas that are too big for the veneers to bridge. Grind off any high spots that could keep the veneers from lying flat.
2. Bond the first veneer about midpoint on the hull. Use the one-step bonding technique (Section 3.4.2) with an epoxy/low-density filler mix. Staple the veneer so it lies flat against the surface at about a 35° diagonal (*Figure 6-21*). Adjust the angle as necessary to allow the veneer to lie flat along its full length.
3. Bond the remaining veneers of the first layer. Trim the second veneer to fit tight against the first and lie flat against the surface. The ends of the veneer may have to be tapered if the surface is a compound curve. Bond and staple the second veneer in place. Continue trimming and bonding veneers in each direction from the first veneer.
4. Sand the surface fair after the epoxy cures thoroughly. Staples should be removed before sanding unless they are a non-corroding type which may be left in.

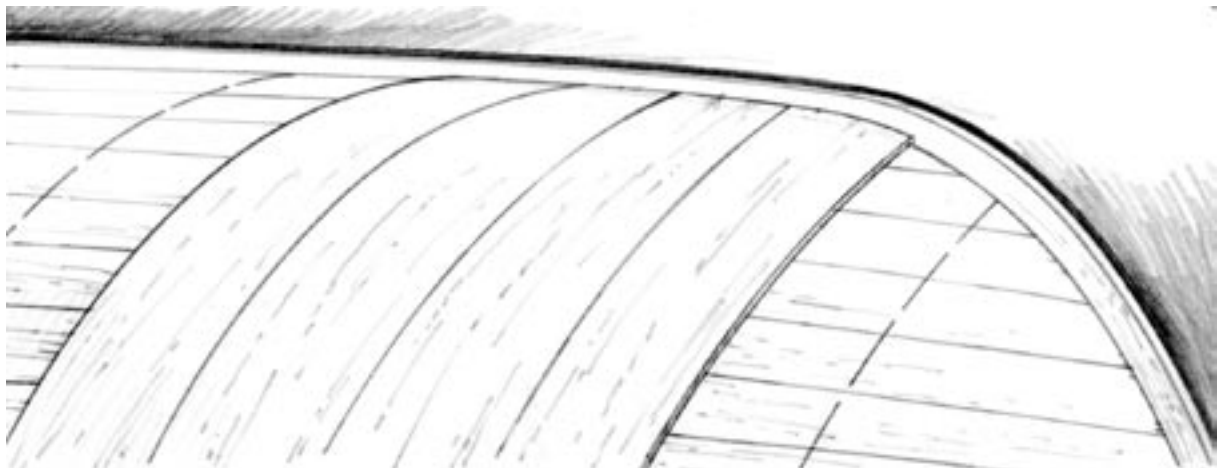

Figure 6-21 Bond the first layer at an angle that allows it to lie flat against the surface.

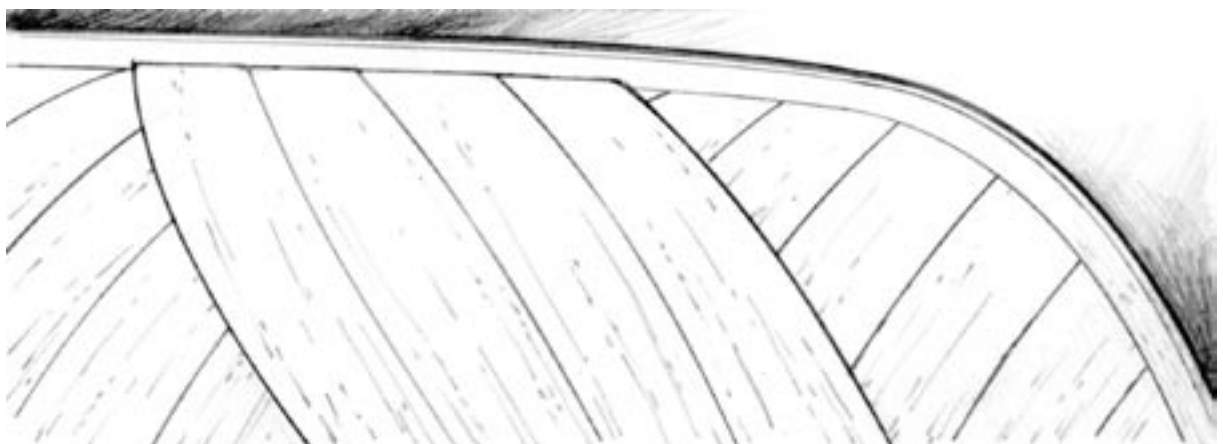

Figure 6-22 Bond the second layer of veneers in the opposite diagonal to the first layer.

5. Repeat the process on the second layer (*Figure 6-22*). Begin with the first veneer about midpoint at a 35° diagonal in the opposite direction to the first layer. Trim and bond the remaining veneers.
6. Repeat the process on the remaining layers. Remove the staples after the last layer has cured. Sand the surface fair and prepare it for final finishing.

6.5 Installing a teak veneer deck

Thin strips of teak bedded in a thick epoxy/graphite layer give the appearance of an authentic teak deck that is both durable and low in maintenance. Although strips of up to 6mm thickness may be used, the effects of dimensional change can be limited by using thinner, 3mm thick strips. A 3mm thick deck will provide years of service in high-traffic areas, and it will keep the additional weight of a new teak deck to a minimum. Strips should be between 37mm and 50mm wide, with edges planed smooth and straight. Leave the flat surfaces (top and bottom) rough sawn. The rough texture left by the saw improves the bonding characteristics of the strip. The remaining marks on the exposed surfaces will be sanded smooth after the new deck has been laid.

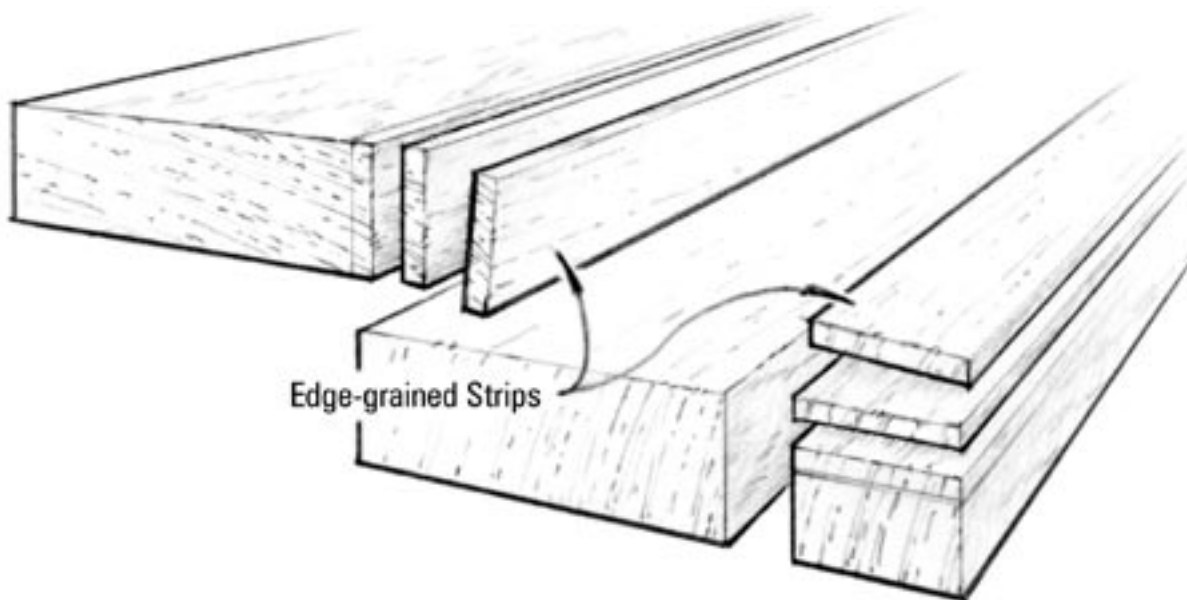

Figure 6-23 Thin edge-grained strips provide an even wearing, attractive and dimensionally stable deck.

If planning to mill the stock, select a plank width that makes the most efficient use of the raw stock. Teak is generally available in 50mm thick, rough-sawn planks; it should be possible to acquire a 44mm finished dimension from these planks. Saw the stock so that the strips will be edge-grained (*Figure 6-23*). This will minimize expansion and contraction of the wood and make a more attractive, even-wearing surface than will slab-grained strips.

Install a teak deck as follows:

1. Plan the pattern for the layout of the teak strips. Place the first teak strips in the desired location and then mark reference location points on the strips and on the deck.
2. Abrade any smooth bonding surfaces with 50-grit sandpaper and remove sanding dust. Wipe the planks with paper towels saturated with an aggressive solvent such as acetone, 30 minutes before bonding.
3. Wet out the mating surface of the first few pieces of teak and the deck in the corresponding area of these strips with unthickened resin/hardener.
4. Apply a thickened epoxy blend over the wet-out deck surface. Use 406 Colloidal Silica to a mayonnaise consistency and add just enough 423 Graphite Powder to turn the mix to an opaque black colour. Apply a layer thick enough to span any gaps and to squeeze up between the planks. An 809 Notched Spreader works well to apply an even layer over the substrate.
5. Locate the reference points and set the first strips in place.

51 Hull and Deck Planking Repairs

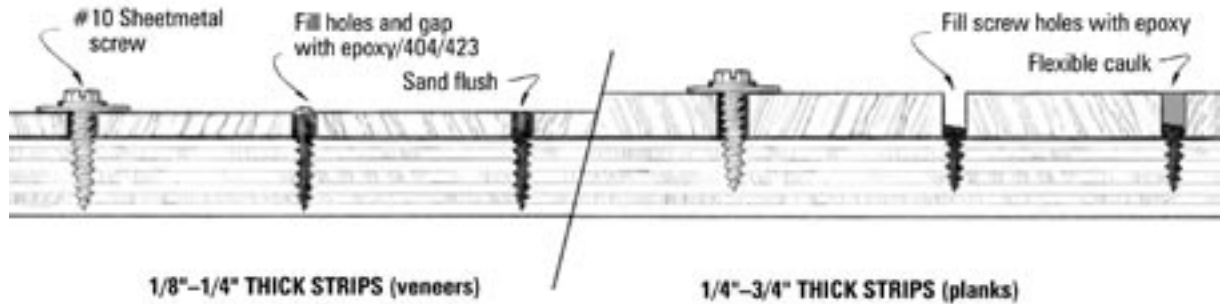

Figure 6-24 Sheet metal screws with large washers will clamp the strips in position until the epoxy/406/graphite mixture cures thoroughly.

6. Clamp the plank in place with #10 sheet metal screws and large washers. Place the screws and washers between the strips, 200mm apart. Each row of screws will clamp the edges of two adjoining planks and act as spacers (*Figure 6-24*). Coat the screws and washers with a mould release or place a small sheet of plastic under the washers to prevent bonding. Washers may also be cut from stiff plastic, thin wood lathe or similar stock with holes drilled for the screws. Tighten the screws down completely after pushing both adjoining strips tight against the screws. The epoxy mix should squeeze up between the strips. Any voids between the planks should be filled at this time with the epoxy/406/graphite blend.
7. Place the remaining strips, several at time, following the same procedure.
8. Allow the epoxy to cure between 8 and 24 hours before removing the screws and washers. If waiting any longer than this, it will become much harder to break the screws free. Tighten the screw slightly (5°) before backing it out. If it is difficult to remove a screw, heat the head with a cutting tip of a soldering gun. While the screw is still hot, try to unscrew it again. Repeat until successful.
9. Fill the screw holes with epoxy/406/graphite blend. A syringe loaded with the composition will speed the process.
10. Sand the surface with a reciprocating sander and 50-grit sandpaper to level the epoxy and teak surfaces. Sand until the saw marks are removed from the teak surface. Fine sand with 80-grit sandpaper, and then finish with 120-grit. The teak surface may be left natural or finished with a marine-grade teak oil.

Section 7

7 Installing Hardware

Now that the deck is upgraded, the hardware should receive the same thorough attention. To overcome problems associated with hardware installation on wooden boats, Gougeon Brothers, Inc. has developed an approach called hardware bonding. As the name implies, hardware items are bonded to wood to distribute high, single-point loads over as large an area of wood fibre as possible, while allowing the epoxy to seal and protect the wood end grain exposed by the fastener hole.

There are two ways to do this. The first is to bond all fasteners (screws, bolts or threaded rod) directly to the surrounding wood fibre. The second is to bond both the fasteners and the hardware to the immediate wood fibre on which it rests. Using proper hardware bonding installation techniques, the load-carrying capacity of the hardware can be dramatically improved over that possible with standard hardware installation methods.

In saltwater applications, our experience shows that bonded hardware and fasteners show excellent resistance to corrosion attack. Where fasteners are vulnerable to flexure and saltwater attack (i.e., hollow or bridged traveller tracks, bonded U-bolts or solitary eyebolts) a small silicone sealant fillet covering the joint between the cured epoxy and the fastener will protect against moisture and salt intrusion. Of course, any exposed metal surface will be subject to the effects of saltwater corrosion; therefore proper maintenance and cleaning procedures must be practiced.

7.1 Fastener bonding

The fastener-to-wood bond can be completed in several ways. The easiest and most common method is simply to wet out a standard-size pilot hole for a given fastener with resin/hardener.

Produce fastener bonds as follows:

1. Use a pipe cleaner or syringe to work the mixed epoxy well into the hole.
2. Insert the fastener in the hole and allow the epoxy to cure.

This forms a wood/epoxy matrix around the fastener that is much stronger than the wood by itself, and distributes the fastener load over more of the wood fibre area.

7.2 Hardware bonding

Further improvements to the load-carrying capability of the hardware can be made by increasing the amount of epoxy that surrounds the fastener — taking advantage of the fact that WEST SYSTEM epoxy has much higher density and strength than the wood fibre itself — and bonding the hardware base directly to the surface.

Bond for increased load transfer as follows:

1. Drill an oversized pilot hole to increase the amount of exposed wood area to which the epoxy will adhere around the fastener. This may be much larger than the fastener—twice the fastener diameter, for example. Drill the hole $\frac{2}{3}$ to $\frac{3}{4}$ the depth of the fastener.

53 Installing Hardware

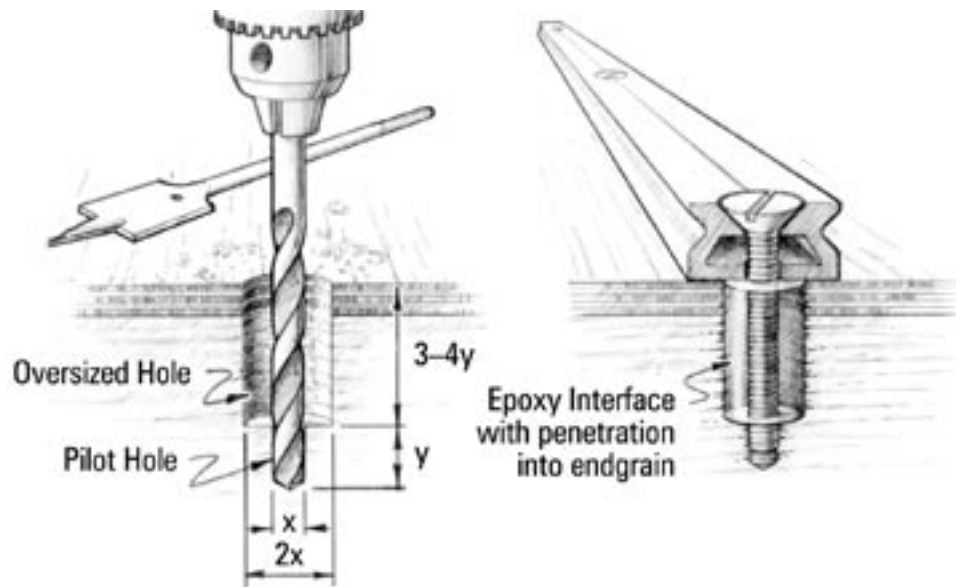

Figure 7-1 A normal sized pilot hole at the bottom of the oversized hole provides enough clamping pressure to hold the hardware in position until the epoxy cures.

2. Drill a normal sized pilot hole at the bottom of the oversized hole to the full length of the fastener (Figure 7-1). This allows the bottom threads of the fastener to bite into the wood fibre so that the fastener will stay in the correct position until the epoxy cures.
3. Prepare the hardware by washing the contact surface of the base with solvent to remove any contamination. Abrade the contact surface with a wire brush or 50-grit sandpaper to allow the epoxy to “key” into the surface.
4. Fill the holes to the top with epoxy. Allow the epoxy to soak into the exposed end grain of the wood for a few minutes. If the hole remains filled after 5 minutes, remove the epoxy with the syringe.
5. Coat the bottom contact surface of the hardware with unthickened epoxy. Wire brush or sand the wet epoxy into the surface with 50-grit sandpaper. Sanding the base, coated with epoxy, will expose the epoxy directly to fresh metal allowing no possibility for the metal to oxidize.
6. Inject a non-sagging epoxy filled with either 404 or 406 blend into the hole. Use enough mix so that there are no voids in the hole after inserting the fastener. Coat the bottom of the hardware and the fastener threads with the thickened mix.
7. Place the hardware in position. Insert and tighten fasteners until a small amount of the epoxy/filler mix squeezes out of the joint. Do not overtighten.
8. Clean the excess epoxy mixture that has squeezed out.
9. Allow the epoxy to cure at least 24 hours before applying load to the hardware. Allow more time in cool weather.

7

Bonding the contact surface of a hardware item can contribute a great deal to load distribution over maximum wood surface area. WEST SYSTEM epoxy can be used to make good bonds with most metals but careful preparation of the metal surface is necessary for good adhesion. This includes sanding and acid etching. For example, aluminum requires a two-step surface preparation. The first step involves the use of an acid conditioner that removes corrosion. The second step chemically stabilizes the surface and prevents oxidation, allowing time for coating or bonding.

7.3 Casting epoxy bases for hardware

Occasionally, fittings must be set at specific angles to the hull or deck surfaces. Downrigger bases, lifeline stanchions, winches and turning blocks are all good examples. Traditionally, hand-carved, wedge-shaped shims have been used to achieve the correct angles with such fittings. Unfortunately, wooden shims require a great deal of time and carpentry skill. Hardware casting can save time and is easier to complete; more importantly, it can result in a stronger, waterproof base. Cast the hardware at an angle to the surface as follows:

1. Prepare the bonding surfaces. Clean the substrate and hardware bonding surfaces with solvent (eg Acetone) to remove any contaminants. Sand the deck with 50-grit sandpaper. Apply a release agent, such as an automobile wax or a silicone polish, to the base of the hardware.
2. Position the hardware. Mark the outline of the hardware and shim it to its desired angle. Mark the shim locations. Often one edge of the fitting will rest on the deck and become the zero point for the required angle.
3. Wet out the substrate (deck) surface with resin/hardener mix except for the shim locations.
4. Cast epoxy supports under the hardware (*Figure 7-2A*). Prepare a blend of resin/hardener/404 High-Density filler to peanut butter consistency. Use the mixing stick to place three portions of the mixture within the hardware outline, evenly spaced around the perimeter. Use enough of the composition and pile the mix high enough to contact the base of the hardware when it is shimmed in its proper position. When cured, the epoxy supports will take the place of the temporary shims. Set the fitting in place with the temporary shims holding the hardware at the proper height and angle. The bottom of the hardware should contact all three epoxy supports. Allow the epoxy supports to cure thoroughly.
5. Tap the hardware with a mallet to break it loose and remove the temporary shims. Mask off the area around the fitting with duct tape and plastic in case of accidental epoxy spills.
6. Prepare the deck and hardware for casting the base. Wash and sand the cured epoxy in the deck base area. Reapply mould release to the hardware base. At this time, mask off areas of the hardware that are not to come into contact with the epoxy. It would be helpful to place small pieces of tape over the holes in the hardware item to prevent the epoxy from oozing up through when the piece is re-positioned.
7. Apply enough thickened epoxy/404 to a peanut butter consistency to fill the entire base area. If the base to be cast is more than 12mm thick, use 206 Slow Hardener to reduce the possibility of exothermic heat build-up during the curing process. Build up the mix slightly higher than the base supports, roughly forming the shape of the base. Fill all voids around the epoxy supports.
8. Reset the hardware in its correct location. Slowly press it into the proper position on top of the cast epoxy supports. Allow excess epoxy mix to squeeze out of the gap between the base of the hardware and the deck. Sculpt the squeezed out mix into the desired shape (*Figure 7-2B*). A standard fillet works well in this situation (Section 3.4.3). Add extra mix if necessary for shaping or to fill any voids. Remove any excess before it cures. Allow the epoxy to cure thoroughly.

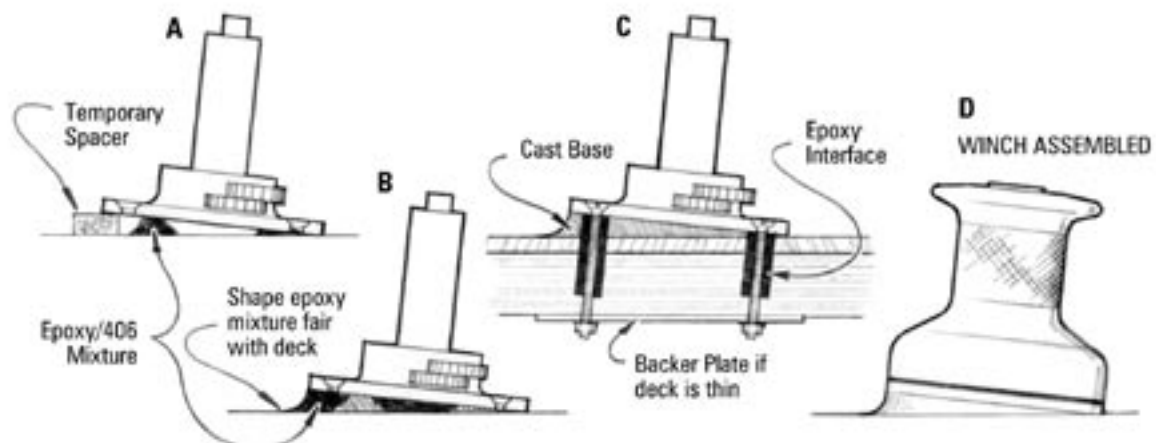

Figure 7-2 Hardware casting is an excellent method for installing a piece of hardware that is not flush to the deck such as a winch.

9. Tap the hardware with a mallet to remove it from the base. Clean the bottom of the hardware and the top of the cast base with solvent (eg Acetone) to remove the mould release. Sand both bonding surfaces with 50-grit paper.
10. Sand the cast base to the desired final finish. Begin with 50-grit sandpaper or a file if the base is extremely irregular. Finish with 80-grit sandpaper.

55 Installing Hardware

11. Bond the hardware to the cast base using the hardware bonding procedure in section 7.2 (*Figure 7-2C*). Drill oversized and standard pilot holes for the fasteners through the cast base. Allow to cure thoroughly before applying loads to the hardware. Apply three coats of resin/hardener mix to the base before final finishing.

7.4 Removable hardware

Testing at Gougeon Brothers, Inc. has shown that with bonded fasteners (screws, bolts, threaded rods, etc.), the adhesive bond to the metal is not as important as the “keying” between the epoxy and the threads of the fastener. This factor allows the builder to coat the fastener with a thin film of mould release before bonding to allow easy fastener removal after the epoxy cures.

Fatigue tests of bonded threaded rods with and without a thin coating of mould release show only a 4-10% reduction in the overall fatigue strength of the fastener with mould release. A thin film mould release will yield a more predictable performance than a thick film. Suitable mould releases are based on paste wax or silicone sprays. While the reduction in strength of the fastener treated with mould release is slight, it should be taken into account when calculating hardware loads. We recommend adhesive bonding to all hardware and fasteners rather than the use of mould release whenever possible.

7.5 Removing bonded hardware

Occasionally it is necessary to remove bonded hardware items. At temperatures above 65°C, cured epoxy begins to lose its physical properties; the resin softens and its bonding capacity is reduced considerably. By using this characteristic to one’s advantage it is possible to remove a piece of bonded hardware.

1. Remove all fasteners. If a release agent was used when the fasteners were bonded in place, they should come loose without too much difficulty. If the fasteners were bonded in, it will be necessary to apply heat to them, using a soldering iron. The epoxy around the fastener will soften enough to loosen the fastener when enough heat is conducted down the fastener.
2. Heat the fitting briefly with a propane torch. Protect the area around the fitting from heat damage by covering with water-soaked plywood. Allow the heat to conduct through the base of the hardware. A sharp rap with a mallet should be enough to dislodge the hardware. If the fitting does not break loose easily the first time, do not force it. Heat it a second time with the torch and try again.
3. Replace the hardware by following the procedures in Section 7.2. Redrill the fastener holes in the existing epoxy as if completing a new installation.

Section 8

8 Protective Coatings and Maintenance

8.1 Sunlight and protective coatings

Sunlight poses a threat to the structure and finish of all composite boats. It attacks in two ways: heat and ultraviolet (UV) rays. Any epoxy finish without protective coatings are vulnerable to ultraviolet degradation. WEST SYSTEM® Brand epoxy, including the 207 Special Coating Hardener, is not intended to be used as a final finish. Therefore, it is recommended to cover bare epoxy that will be exposed to direct sunlight as soon as possible with an opaque paint or an ultraviolet inhibiting coating. If the surface is to be painted, add pigment to the last two coats of epoxy to protect the surface. Surfaces that receive indirect UV exposure, such as those below decks, will last much longer without a protective coating than directly exposed surfaces.

While a clear coating has an inherently shorter lifespan than a paint finish, there is a tradition among wooden boat owners of using clear coatings to preserve and enhance the natural beauty of wood. For many, the major attraction of wooden boats is the beauty of wood itself and they are willing to invest a lot of time and money to achieve near perfection in their wood finishes.

Unfortunately, due to the exposure to the sun, these beautiful finishes seldom last forever. The boats must ultimately be stripped down and recoated, usually at great expense. Because of this, owners want the finish to have the longest possible lifespan.

The first phase of finish breakdown is loss of gloss, so surface gloss retention is essential for coating longevity. Breakdown of a clear coating by sunlight has two root causes. The first is the gradual breakdown of the coating material. The second is the slight chemical and physical change which takes place within the surface wood cells affected by the sunlight through the clear coating. It is thought that this change in the wood cells contributes to the coating failure by promoting a physical separation of an already weakened coating from the wood surface.

We are often asked how long a coating will last over a wooden surface. The answer is not simple, because the lifespan of any coating depends on many factors. We consider the following to be the most important:

1. The number of hours of exposure to sunlight in a given climate. Cloudy climates are less hostile than sunny climates. A location in the Southern Mediterranean is far worse than one in Northern Europe because on average the solar radiation in the Southern Mediterranean is less filtered by the atmosphere.
2. The angle of the exposed surface to the sunlight. For example, a deck will receive much more direct radiation at high noon, when the destructive UV rays of the sun are most damaging, than would cabin sides.
3. Highly glossy surfaces are more reflective of UV rays (and thus less vulnerable) than are dull surfaces, no matter what the colour.
4. Lighter coloured woods are more reflective than darker coloured woods, just as lighter coloured paints are far more reflective than are darker colours (*Figure 8-1*).

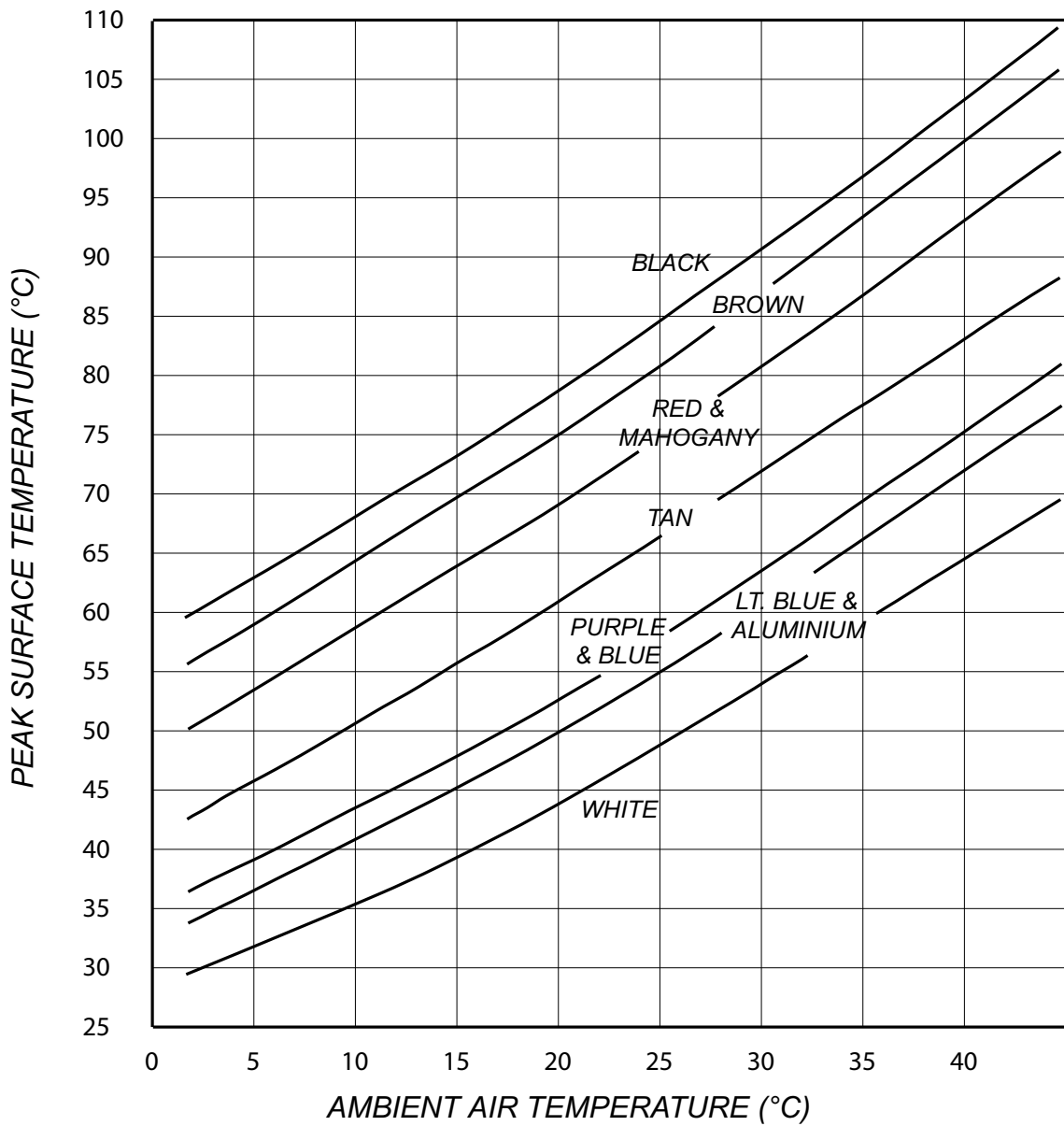

Figure 8-1 Effect of colour on surface temperature under sunlight.

5. Thicker clear coatings last longer and offer more protection than thinner coatings.
6. Varnishes with large amounts of UV inhibitors last much longer than varnishes without this additive. Modern two-part polyurethane varnishes last longer than the more traditional phenolic varnishes.
7. A high-strength epoxy resin undercoating, such as WEST SYSTEM 105/207 mix, when used as a saturation coat under a varnish, provides a greater lifespan than the use of varnish alone. A bonus is the dramatically improved moisture resistance.

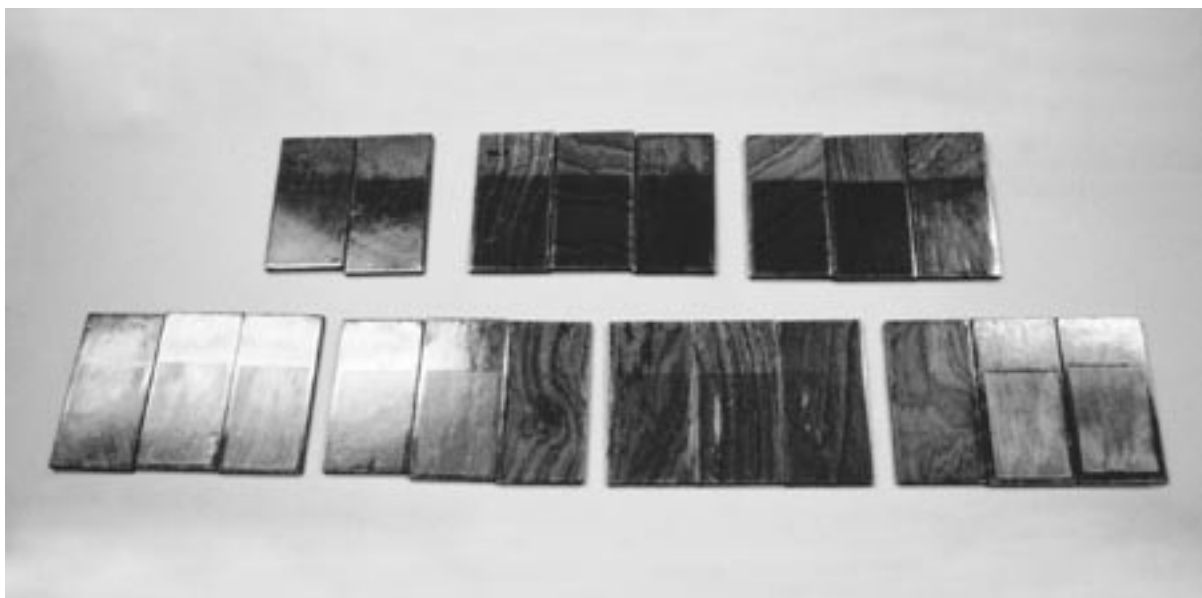

Figure 8-2 UV test samples after 3600 hours in weathering machine.

Gougeon Brothers, Inc. has studied the effect of these factors through many years of observation and experimentation with all types of finishes, particularly clear finishes. In the laboratory, Gougeon Brothers Inc. has used a weathering machine to accelerate UV damage to coated surfaces so that a direct comparison can be made between different products, finish types, surface preparations, and coating substrates in a controlled test environment (*Figure 8-2*). This testing has allowed for evaluation of a wide range of variables and samples and has guided Gougeon Brothers Inc. in the development of WEST SYSTEM 207 Special Coating Hardener. When used with, a high quality two-part polyurethane they provide a superior quality clear finish with excellent resistance to damage from moisture and UV radiation.

8.2 Applying the final epoxy coatings

As discussed in Section 3.4.7, apply a minimum of three coats of WEST SYSTEM epoxy for moisture resistance and to provide a smooth base for clear coating or paint. If sanding has been carried out between the coatings, apply further coats for a maximum recommended thickness of between 375-500 microns for a deep, long-lasting finish (each coat provides approximately 125 micron thickness).

We recommend WEST SYSTEM 207 Special Coating Hardener be used for the highest quality, longest-lasting clear finish. 207 contains a UV filter that improves the ability of the mixed 105/207 epoxy to resist the harmful effects of sunlight without compromising moisture resistance. If a clear finish is not required, select the hardener (205, 206 or 209) that meets the needs of the job in hand.

General procedures for final epoxy coating are listed in Section 3.4.7. The following are specially applicable for using 207 Special Coating Hardener to prepare for a deep lustrous finish in the fastest possible time:

1. Sand and fair the wood surface using 80-grit or finer paper. Always sand in the grain direction.
2. Apply a saturation coat of 105/207 to the bare wood surface and allow to cure thoroughly at room temperature. The cured saturation coat will cause the wood surface to “swell up” and feel rough. Dry sand or scrape the swelled wood grain to a moderate smoothness. (Be careful to avoid sanding through this initial saturation coat through excessive sanding).
3. Apply a second coat of 105/207 using the roller and foam brush method described in Section 3.4.7. Level out the coating as much as possible.
4. Apply a third coat as soon as the second coat has reached its initial cure (at least 90—120 minutes at 18°C). Take extra care to apply thin, even coats to prevent runs or sags. Add any number of coats to build up the desired coating thickness. Be sure to level out each coating with the foam brush.
5. Allow these coats to cure fully. The cure can be accelerated with moderate heat, but too much heat may cause bubbling.

59 Protective Coatings and Maintenance

6. Wet sand the cured 105/207 epoxy surface to a 220-grit or finer finish. Rinse the surface with clean water. Rinse water should sheet evenly, without beading or fisheyeing. If rinse water beads up (a sign of contamination), wipe the area with solvent and dry with paper towels, then wet sand again until beading is eliminated. Proceed with the finish coating after the surface has dried thoroughly. See Section 3.4.1, *Surface preparation, Special preparation for various materials, Cured epoxy*.

8.3 Applying clear coatings

Even though a properly applied 105/207 coating may have a high gloss finish equal to that of a good varnish, we recommend that this surface be coated with a top quality varnish for UV protection and maximum performance. Two-part polyurethanes bond well to cured WEST SYSTEM epoxy surface and provide great hardness and durability whilst still retaining a high-gloss, UV-resistant surface.

1. Thoroughly mix the two-part polyurethane varnish in the correct ratio.
2. For major applications over large surface areas, always use the 790 Foam Roller which will give a more uniform application in less time. This means runs are less likely during application and there will be more time to touch up the coating later.
3. For smaller areas or surface inaccessible with a roller use a high quality brush with a tapered tip, 50mm to 75mm wide, depending on the intricacies of the surface to be coated.
4. During application, the roller will leave a slightly stippled surface with some air entrapped in the coating. In most instances this stipple will flow out and the bubbles will disappear to leave a smooth, high-gloss surface upon cure. In some conditions, it will be necessary to brush out the rolled-on coating to assist the levelling process. Do this by lightly brushing the surface with smooth, even strokes as soon as possible after applying the varnish. Be aware that the time available to perform this “tipping off” will vary by climate. Cooler temperatures should allow approximately 5 minutes to tip off a newly applied coating with no difficulty; hot, dry conditions will allow much less time.

We are often asked how many coats of varnish should be applied. The answer is the more the better, with the important understanding that the final coat always needs a high gloss for longevity. Initially apply two or three coats over the 105/207 epoxy base and a new coat every second or third year to assure a continued glossy surface. This approach not only renews the surface to a high gloss, but also takes care of any defects or scratches whilst maintaining the UV protective barrier. Thus it has the potential to provide an extremely durable finish.

For health reasons we do not recommend spraying two-part polyurethane. Inhalation of fumes, dust, vapours and droplets must be avoided. Spraying of marine paints in general is not recommended except if done by a trained professional with industrial grade equipment and only in properly ventilated areas.

8.4 Paint

Alternative finishes are fully pigmented paints. Pigments filter out all or most of the harmful UV rays, thus protecting the substrate. However, a slow oxidation of the surface occurs over many years, causing it to lose its gloss. Light coloured paints are more reflective and maintain their gloss longer than darker colours. Protecting the substrate from heat is another important reason to choose lighter colours (*Figure 8-1*).

There are a number of different types of paint systems available including enamel, polyurethane (both one and two part) and linear polyurethane. Some coatings are more durable than others, whilst some can be hazardous to apply. The more recently developed linear polyurethanes (LP) are superior to any other paint we have used. We recommend them as the best painting system to use over a cured WEST SYSTEM epoxy surface. The LP systems have excellent resistance to sunlight, salt spray and other weathering factors. They possess outstanding abrasion resistance and hardness that can equal or surpass that of polyester gel coat. Best of all, LP paints bond well to a cured WEST SYSTEM epoxy surface. We recommend contacting a reputable paint manufacturer to seek advice on the best paint system available to meet the needs of the job in hand.

Always follow the instructions from the manufacturer of the paint. Nevertheless, it is recommended to make a test panel to evaluate the degree of surface preparation required, the compatibility and the handling characteristics of the finish system.

Whichever system is chosen, it is important to ensure adequate surface preparation is carried out in accordance with both section 3.4.8 of this manual and the coating manufacturer's instructions and information.

8.4.1 Primers

Most finish coatings adhere to an epoxy-coated surface that has been well sanded, although interfacing primers are required with some paints, particularly specialized bottom paints (anti-fouling). If the manufacturer's instructions for the paint or varnish recommend a primed surface, sand the epoxy coating until it is no longer glossy and follow the directions given by the manufacturer for preparation. Test the product in an inconspicuous area to be sure that it will bond to epoxy. If any product fails to dry within the period specified on its packaging, contact the manufacturer.

A coloured base coat will ease final fairing by serving as a guide to prevent oversanding and will also reduce the number of coats of paint needed to cover an unpainted surface. When we plan to paint a hull, we add WEST SYSTEM Colour Pigment to our final coat of epoxy, and use this as a tracer coat.

8.5 Repairing dents and cracks

After repair or restoration, continue to inspect the boat carefully for damage. Look for hairline cracks at the joints. There will probably be some in the first year after the repair. Check if boat flexure is the source of the crack or if moisture intrusion is causing expansion and cracking. It is not necessary to repair these cracks immediately. When the boat is hauled out, sand or scrape the cracks slightly and allow the area to dry. Repair the epoxy coating and replace any paint or varnish used over it.

Touch up dents or defects to the varnish or paint to maintain their effective moisture and UV barriers. Plan to apply a new coat of varnish every two or three years, or when ever repair work is carried out.

8.6 Ventilation for longevity

Ventilation is a key factor in the continued longevity of the boat. Keeping the interior as dry as possible is the best preventive maintenance for preserving the structure and making the boat more comfortable.

Keep the bilges as dry as possible. This is a good idea whether or not the bilges are coated with epoxy. Make sure that drainage is good and that there are no hidden areas in the bilges where water can lie. Limber holes should be large and open. For safety and longer coating life, keep fuel and oil out of the bilges.

An open interior layout is better for ventilation. Do not let rubbish build up. Ensure that no water-absorbent materials (leaves or clothing) are in contact with the hull or interior joinery work.

Watertight deck or cabin openings and effective ventilators with good drainage (such as dorade boxes or mushrooms) can make the boat more comfortable when in use and drier at the dock or mooring.

All of these factors work together to provide good ventilation. If you have questions about options, we suggest consulting the books listed in Appendix D.

Appendix A

Product buying guide

FILLER BUYING GUIDE

The following chart indicates the percentage of filler required to produce an adhesive and a filler consistency for the various filler products.

RECOMMENDED MIXING SPECIFICATIONS: PERCENTAGE BY WEIGHT ADDITION TO MIXED WEST SYSTEM EPOXY. ALL FIGURES ARE AN APPROXIMATE GUIDE		
FILLER	ADHESIVE MIX (for bonding)	FILLER MIX (for filling & fairing)
403	7%	16%
404	45%	60%
405	20%	25%
406	5%	8%
407	30%	35-40%
410	-	16%

EPOXY COVERAGE RATES

The following chart indicates the coverage rate of 1.0 kg of mixed WEST SYSTEM epoxy.

ESTIMATING COATING COVERAGE OF MIXED WEST SYSTEM EPOXY		
1.0 kg of mixed epoxy	SATURATION COAT POROUS	BUILD-UP COATS NON-POROUS
105 Resin with either 205 or 206 Hardener	6.5 - 7.5 m ²	8.5 - 9.5 m ²
105 Resin with either 207 or 209 Hardener	7.0 - 8.0 m ²	9.0 - 10.0 m ²
ADDING FILLERS OR WETTING OUT FABRICS WILL DECREASE COVERAGE		

FIBREGLASS THICKNESS PER LAYER

Product Number	740	741	743	731	738
Fabric Type	Plain	Plain	Twill	Biaxial	Biaxial
Fabric Weight (g/m ²)	135	200	280	406	602
*Single Layer Thickness (mm)	0.10	0.25	0.39	0.44	0.53

*Average of multiple layers applied by hand lay-up. These values are for guidance only because of the variables incurred during laminating e.g. resin: fibre ratio.

Appendix B

WOOD DATA

A-1 Mechanical properties of woods commonly used with WEST SYSTEM® Brand Epoxy¹

Species	Specific gravity ²	Modulus of rupture		Static bending		Pounds per cubic inch	Compression		psi	psi	psi	psi	psi	Pounds	Inches
		psi	Million psi	Modulus of elasticity ²	Work to maximum load		parallel to grain-maximum crushing strength	perpendicular to grain-fibre stress at proportional limit							
Ash, White	.55	9,600	1.44	16.6	3,990	670	1,380	590	960	38					
Balsa, medium	.60	15,400	1.74	17.6	7,410	1,160	1,950	940	1,320	43					
Balsa, yellow	.17	2,900	.58	-	1,805	100	300	118	100						
Cedar, Alaskan	.55	8,300	1.50	16.1	3,380	430	1,110	430	780	48					
Cedar, Northern white	.62	16,600	2.01	20.8	8,170	970	1,880	920	1,260	55					
Cedar, Port Orford	.42	6,400	1.14	9.2	3,050	350	840	330	440	27					
Cedar, western red	.44	11,100	1.42	10.4	6,310	620	1,130	360	580	29					
Douglas fir, coast	.29	4,200	.64	5.7	1,990	230	620	240	230	15					
Hickory	.31	6,500	.80	4.8	3,960	310	850	240	320	12					
Lauan, light red	.39	6,600	1.30	7.4	3,140	300	840	180	380	21					
Mahogany, Honduras	.43	12,700	1.70	9.1	6,250	720	1,370	400	630	28					
Meranti, dark red	.32	7,500	.94	5.0	2,770	240	770	230	260	17					
Okoume Gaboon	.45	7,700	1.11	5.8	4,560	460	990	220	350	17					
Pine, loblolly	.48	12,400	1.56	7.6	3,780	380	900	300	500	26					
Pine, longleaf	.54	8,500	1.11	9.9	7,240	800	1,130	340	710	31					
Pine, white	.59	14,500	1.57	23.7	4,580	840	1,520	NA	NA	74					
Ramin	.34	4,900	.99	5.2	2,440	220	680	250	290	17					
Spruce, black	.35	8,600	1.24	6.8	4,800	440	900	310	380	18					
Spruce, Sitka	.59	9,800	1.57	9.0	5,395	NA	994	640	640	NA					
Teak	NA	18,400	2.17	17.0	10,080	NA	1,514	100	1,300	NA					
	.38	5,400	1.06	7.4	2,570	140	660	370	370	24					
	.40	10,300	1.53	10.5	5,320	530	1,030	250	520	23					
	.37	5,700	1.23	6.3	2,670	280	760	350	350	24					
	.40	10,200	1.57	9.4	5,610	580	1,150	370	510	25					
	.57	11,000	1.51	10.8	5,470	NA	1,290	1,070	1,070	NA					
	.63	12,800	1.59	10.1	7,110	NA	1,480	1,030	1,030	NA					

¹Extracted from Forest Products Laboratory, Wood Handbook, U.S. Department of Agriculture Handbook No. 72. (Government Printing Office, Washington, D.C., 1974), pp. 4-7-4-17. Results of test on small, clear, straight-grained specimens. Values in the first line for each species are from tests of green material; those in the second line are adjusted to 12% moisture content.

²Modulus of elasticity measured from a simply supported, center loaded beam, on a span ratio of 14 to 1. The modulus can be corrected for the effect of shear deflection by increasing it 10%.

³Specific gravity is based on weight when oven dry and volume when green, or at 10% moisture content.

⁴Trademark of Gougeon Brothers, Inc., U.S.A.

63 Appendix

A-2 Percentage increase in wood strength properties for 1% decrease in moisture content^{1,2}

Species	Static bending				Compression parallel to grain - maximum crushing strength	Compression perpendicular to grain	Shearing strength parallel to grain	Side Hardness
	Fibre stress at proportional limit	Modulus Of rupture	Modulus of elasticity	Work to maximum load ³				
Ash, white	4.1	3.5	1.4	0.4	4.7	4.8	2.9	2.4
Birch, yellow	6.0	4.8	2.0	1.7	6.1	5.6	3.6	3.3
Cedar, northern white	5.4	3.6	1.8	-1.5	5.9	2.3	2.8	3.0
Cedar, Port Orford	5.7	5.2	1.6	1.7	6.2	6.7	2.2	2.8
Cedar, western red	4.3	3.4	1.6	1.3	5.1	5.1	1.6	2.3
Fir, Douglas	4.5	3.7	1.8	1.9	5.5	5.0	1.7	2.9
Hickory, true	4.9	4.8	2.8	-0.7	5.9	6.6	-3.9	-
Mahogany, Honduras	2.6	1.3	0.8	-2.9	2.5	3.9	-	1.0
Pine, eastern white	5.6	4.8	2.0	2.1	5.7	5.6	2.2	2.2
Spruce, Sitka	4.7	3.9	1.7	2.0	5.3	4.3	2.6	2.4

¹ Extracted from Munitons Board Aircraft Committee, Design of Wood Aircraft Structures, ANC-18, 1951 (National Technical Information Service/U.S. Department of Commerce Reprint AD-490 100, Springfield VA). P.13.

² Corrections to the strength properties should be made successively for each 1% change in moisture content until the total change has been covered. For each 1% decrease in moisture content, the strength is multiplied by (1 + P), where P is the percentage correction factor shown in the table and expressed as a decimal. For each 1% increase in moisture content, the strength is divided by (1 + P),

³ Negative values indicate a decrease in work to maximum load for a decrease in moisture content.

A-3 Oven dry weight of veneers of varying thicknesses by species¹

Species	Specific gravity ²	% Air dry moisture content	Ounces per square foot veneer			
			Veneer thickness in inches			
			1/16	1/8	3/16	1/4
Ash, white	0.58	8.9	3.02	6.04	9.05	12.06
Birch, yellow	0.63	9.6	3.28	6.56	9.84	13.12
Cedar, Spanish	0.37	7.3	1.92	3.85	5.77	7.70
Cedar, red	0.31		1.83	3.67	5.49	7.34
Fir, Douglas	0.51	6.2	2.65	5.30	7.96	10.6
Mahogany, African	0.46	8.0	2.39	4.78	7.17	9.57
Mahogany, Central American	0.49	7.9	2.55	5.10	7.66	10.20
Spruce, Sitka	0.38	8.9	1.98	3.96	5.94	7.94

¹ Extracted from Michelin and Devereaux. P.163

² Based on oven dry weight and air dry volume.

A-4 Approximate weights of finished Western red cedar laminates¹

Number of & inch thick layers	Average pounds per square foot
4 (Totalling ½ inch)	1.30
5 (Totalling ⅝ inch)	1.65
6 (Totalling ¾)inch)	2.00
7 (totalling ⅞ inch)	2.35
8 (totalling 1 inch)	2.70
9 (totalling 1 ⅛ & inch)	3.00

¹ Includes weight of WEST SYSTEM resin used in bonding and coating all surfaces. All samples were weighed at the Gougeon Brothers, Inc. test facility.

Appendix C

Custom and commercially available tools used in this manual

Power tool inventory:

255mm (10") tilting arbor table saw.

180mm (7-1/4") electric circular saw.

Electric saber saw / jig saw.

175mm (7") electric orbital polisher with an 12mm foam sanding pad. Uses 200mm stick on sanding discs. 50 and 80 grit are most commonly used for fast wood removal and shaping.

Finishing sander—Either 100mm x 200mm or 100mm x 100mm.

1-1/2 horsepower router.

The need for any of these tools depends on the size of the repair or the particular operation in hand. If these tools are not available, we recommend purchasing only as the need arises. While this may seem a small inventory compared to the range of power tools available, those listed along with the hand tool shown here should enable the projects included in this manual to be completed.



Figure 1 – Minimal tool inventory: (1) combination square; (2) 600mm level; (3) scissors; (4) sliding bevel or bevel square; (5) standard drill bits; (6) spade drill bits; (7) electric drill motor; (8) block plane; (9) compass; (10) 7,0 m measuring tape; (11) chalk line; (12) hammer; (13) screwdrivers; (14) rasp; (15) utility knife; (16) keyhole saw; (17) chisel; (18) staple removing tool; (19) staple gun.

Tipping off brush - from roller

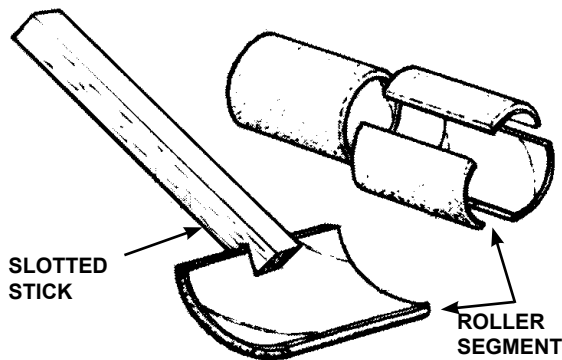

Scraper from an old file

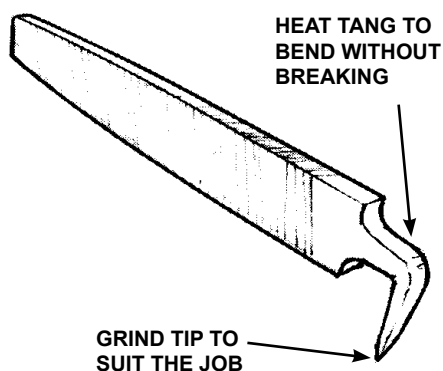

Figure 2 – Broader tool inventory: (A) crosscut saw; (B) back saw; (C) coping saw; (D) large set spade bits; (E) large set drill bits; (F) electric saber saw; (G) awl; (H) spokeshave; (I) plumb bob; (J) jack plane; (K) bench or smoothing plane; (L) Surform tool; (M) offset chisel; (N) chisel assortment; (O) file & rasp assortment; (P) protractor; (Q) calipers; (R) dividers; (S) whetstone.



Appendix D

Suggested Further Reading

- Bingham, Bruce. THE SAILOR'S SKETCHBOOK. Camden, ME: Seven Seas, 1983.
- Butler, Paul and Marya. FINE YACHT FINISHES FOR WOOD AND FIBERGLASS BOATS. Camden, ME: International Marine Publishing Co., 1987.
- Chapelle, Howard L. BOATBUILDING. New York: W. W. Norton & Co., 1969.
- Duffett, John. BOAT OWNER'S GUIDE TO MODERN MAINTENANCE. New York: W. W. Norton & Co., 1985.
- Editors of WoodenBoat Magazine. WOODEN BOAT: AN APPRECIATION OF THE CRAFT. Reading, MA: Addison-Wesley Publishing Co., 1982.
- THE GOUGEON BROTHERS ON BOAT CONSTRUCTION. Bay City, MI: Gougeon Brothers, Inc., 1985.
- McIntosh, David C. "Bud". HOW TO BUILD A WOODEN BOAT. Brooklin, ME: WoodenBoat Publications, Inc., 1987.
- Monk, Edwin. MODERN BOAT BUILDING. New York: Charles Scribner's Sons, 1973.
- Skoog, Jim. CRUISING IN COMFORT. Camden: International Marine Publishing Co., 1986.
- Spurr, Daniel. SPURR'S BOAT BOOK: UPGRADING THE CRUISING SAILBOAT. Camden, ME: Seven Seas, 1990.
- Steward, Robert M. BOATBUILDING MANUAL. Camden, Me: International Marine Publishing Co., 1980.
- D** Temple, Mark O. THE COMPLETE STEP-BY-STEP BOAT REPAIR & RESTORATION HANDBOOK. Blue Ridge Summit, PA: TAB Books Inc., 1981.
- Trefethen, Jim. WOODEN BOAT RENOVATION. Camden, ME: International Marine Publishing Co.

Publications

002-950 WEST SYSTEM® User Manual & Product Catalogue

The primary guide to safety, handling and the basic techniques of epoxy use. Includes a complete description of WEST SYSTEM epoxy resin, hardeners, fillers, additives, reinforcing materials, tools, supplies and publications.

002 The Gougeon Brothers on Boat Construction

This book is a must for anyone building a boat or working with wood and WEST SYSTEM epoxy. Includes extensive chapters on composite construction techniques, materials, lofting, safety and tools, with many illustrations, diagrams and photographs.

002-550 Fibreglass Boat Repair & Maintenance

A complete guide to repair fibreglass boats with WEST SYSTEM epoxy. Includes illustrated procedures for structural reinforcement, deck and hull repair, hardware installation, keel repair and teak deck installation. Softcover 75 pages.

002-650 Gelcoat Blisters-A Guide to Osmosis Repair

A guide for repairing and preventing gelcoat blisters in fibreglass boats with WEST SYSTEM Epoxy. Includes an analysis of the factors that contribute to blister formation and illustrated steps for preparation, drying, repairing and coating for moisture protection.

002-150 Vacuum Bagging Techniques

A step-by-step guide to vacuum bag laminating, a technique for clamping wood, core materials and synthetic composites bonded with WEST SYSTEM Epoxy. Discusses theory, moulds, equipment and techniques used to build composite structures.

002-740 Final Fairing & Finishing

Techniques for fairing wood, fibreglass and metal surfaces. Includes fairing tools, materials and a general guide to finish coatings.

Videos

002-894 Fibreglass Repair with WEST SYSTEM Brand Epoxy

A guide to structural repair on fibreglass boats. Covers repairs to cored and non-cored panels and how to apply gelcoat over epoxy repairs. VHS—20 min.

002-896 Gelcoat Blister Repair with WEST SYSTEM Brand Epoxy

A guide for repairing and preventing gelcoat blisters on fibreglass boats. Includes an analysis of the factors contributing to blister formation and steps for preparation, drying, repairing and coating for moisture protection. VHS—16 min.

002-550 Fibreglass Boat Repair & Maintenance

Published by:

Wessex Resins & Adhesives Limited,
Cupernham House
Cupernham Lane
Romsey
Hampshire
SO51 7LF

Telephone: +44 (0) 1794 521111
Facsimile: +44 (0) 870 7701032
Technical Support
Helpline: +44 (0) 870 7701030

email: information@wessex-resins.com
Web Site: www.wessex-resins.com

Gougeon Brothers, Inc.
PO Box 908
Bay City, MI 48707-0908

Telephone: (001) 989-684-7286
Facsimile: (001) 989-684-1374
Web Site: www.westsystem.com



**WEST
SYSTEM**
BRAND®